

Virtual Machines and Virtualization of Clusters and Data Centers

CHAPTER OUTLINE

Summary	130
3.1 Implementation Levels of Virtualization	130
3.1.1 Levels of Virtualization Implementation.....	130
3.1.2 VMM Design Requirements and Providers.....	133
3.1.3 Virtualization Support at the OS Level.....	135
3.1.4 Middleware Support for Virtualization.....	138
3.2 Virtualization Structures/Tools and Mechanisms	140
3.2.1 Hypervisor and Xen Architecture.....	140
3.2.2 Binary Translation with Full Virtualization.....	141
3.2.3 Para-Virtualization with Compiler Support.....	143
3.3 Virtualization of CPU, Memory, and I/O Devices	145
3.3.1 Hardware Support for Virtualization.....	145
3.3.2 CPU Virtualization.....	147
3.3.3 Memory Virtualization.....	148
3.3.4 I/O Virtualization.....	150
3.3.5 Virtualization in Multi-Core Processors.....	153
3.4 Virtual Clusters and Resource Management	155
3.4.1 Physical versus Virtual Clusters.....	156
3.4.2 Live VM Migration Steps and Performance Effects.....	159
3.4.3 Migration of Memory, Files, and Network Resources.....	162
3.4.4 Dynamic Deployment of Virtual Clusters.....	165
3.5 Virtualization for Data-Center Automation	169
3.5.1 Server Consolidation in Data Centers.....	169
3.5.2 Virtual Storage Management.....	171
3.5.3 Cloud OS for Virtualized Data Centers.....	172
3.5.4 Trust Management in Virtualized Data Centers.....	176
3.6 Bibliographic Notes and Homework Problems	179
Acknowledgments	179
References	180
Homework Problems	183

SUMMARY

The reincarnation of *virtual machines* (VMs) presents a great opportunity for parallel, cluster, grid, cloud, and distributed computing. Virtualization technology benefits the computer and IT industries by enabling users to share expensive hardware resources by multiplexing VMs on the same set of hardware hosts. This chapter covers virtualization levels, VM architectures, virtual networking, virtual cluster construction, and virtualized data-center design and automation in cloud computing. In particular, the designs of dynamically structured clusters, grids, and clouds are presented with VMs and virtual clusters.

3.1 IMPLEMENTATION LEVELS OF VIRTUALIZATION

Virtualization is a computer architecture technology by which multiple *virtual machines* (VMs) are multiplexed in the same hardware machine. The idea of VMs can be dated back to the 1960s [53]. The purpose of a VM is to enhance resource sharing by many users and improve computer performance in terms of resource utilization and application flexibility. Hardware resources (CPU, memory, I/O devices, etc.) or software resources (operating system and software libraries) can be virtualized in various functional layers. This virtualization technology has been revitalized as the demand for distributed and cloud computing increased sharply in recent years [41].

The idea is to separate the hardware from the software to yield better system efficiency. For example, computer users gained access to much enlarged memory space when the concept of *virtual memory* was introduced. Similarly, virtualization techniques can be applied to enhance the use of compute engines, networks, and storage. In this chapter we will discuss VMs and their applications for building distributed systems. According to a 2009 Gartner Report, virtualization was the top strategic technology poised to change the computer industry. With sufficient storage, any computer platform can be installed in another host computer, even if they use processors with different instruction sets and run with distinct operating systems on the same hardware.

3.1.1 Levels of Virtualization Implementation

A traditional computer runs with a host operating system specially tailored for its hardware architecture, as shown in Figure 3.1(a). After virtualization, different user applications managed by their own operating systems (guest OS) can run on the same hardware, independent of the host OS. This is often done by adding additional software, called a *virtualization layer* as shown in Figure 3.1(b). This virtualization layer is known as *hypervisor* or *virtual machine monitor* (VMM) [54]. The VMs are shown in the upper boxes, where applications run with their own guest OS over the virtualized CPU, memory, and I/O resources.

The main function of the software layer for virtualization is to virtualize the physical hardware of a host machine into virtual resources to be used by the VMs, exclusively. This can be implemented at various operational levels, as we will discuss shortly. The virtualization software creates the abstraction of VMs by interposing a virtualization layer at various levels of a computer system. Common virtualization layers include the *instruction set architecture (ISA)* level, hardware level, operating system level, library support level, and application level (see Figure 3.2).

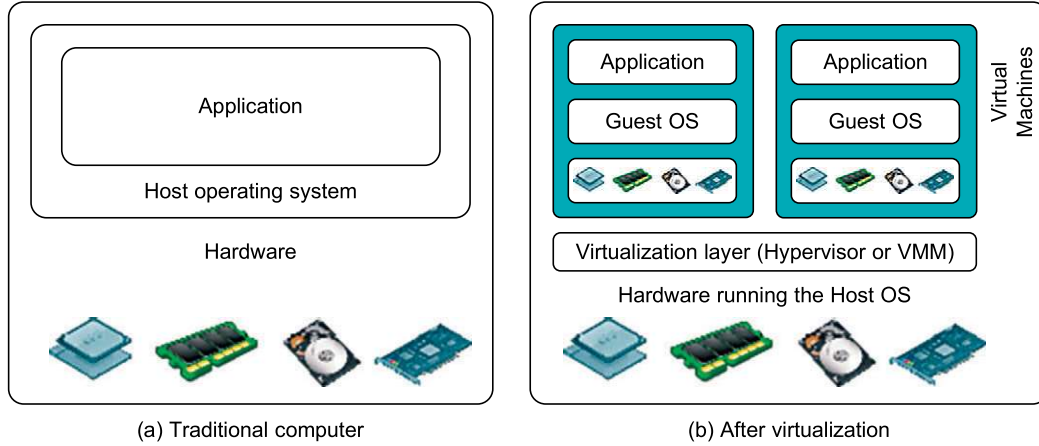

FIGURE 3.1

The architecture of a computer system before and after virtualization, where VMM stands for virtual machine monitor.

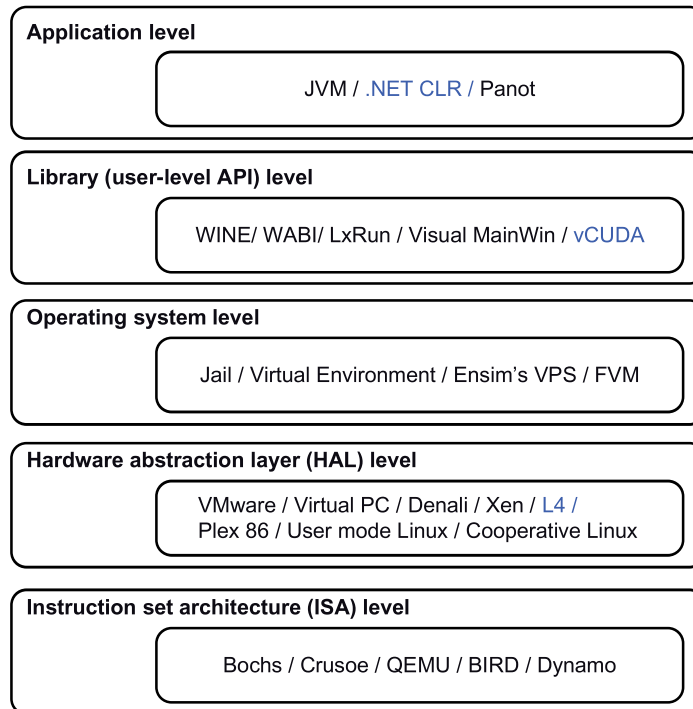

FIGURE 3.2

Virtualization ranging from hardware to applications in five abstraction levels.

3.1.1.1 Instruction Set Architecture Level

At the ISA level, virtualization is performed by emulating a given ISA by the ISA of the host machine. For example, MIPS binary code can run on an x86-based host machine with the help of ISA emulation. With this approach, it is possible to run a large amount of legacy binary code written for various processors on any given new hardware host machine. Instruction set emulation leads to virtual ISAs created on any hardware machine.

The basic emulation method is through *code interpretation*. An interpreter program interprets the source instructions to target instructions one by one. One source instruction may require tens or hundreds of native target instructions to perform its function. Obviously, this process is relatively slow. For better performance, *dynamic binary translation* is desired. This approach translates basic blocks of dynamic source instructions to target instructions. The basic blocks can also be extended to program traces or super blocks to increase translation efficiency. Instruction set emulation requires binary translation and optimization. A *virtual instruction set architecture (V-ISA)* thus requires adding a processor-specific software translation layer to the compiler.

3.1.1.2 Hardware Abstraction Level

Hardware-level virtualization is performed right on top of the bare hardware. On the one hand, this approach generates a virtual hardware environment for a VM. On the other hand, the process manages the underlying hardware through virtualization. The idea is to virtualize a computer's resources, such as its processors, memory, and I/O devices. The intention is to upgrade the hardware utilization rate by multiple users concurrently. The idea was implemented in the IBM VM/370 in the 1960s. More recently, the Xen hypervisor has been applied to virtualize x86-based machines to run Linux or other guest OS applications. We will discuss hardware virtualization approaches in more detail in [Section 3.3](#).

3.1.1.3 Operating System Level

This refers to an abstraction layer between traditional OS and user applications. OS-level virtualization creates isolated *containers* on a single physical server and the OS instances to utilize the hardware and software in data centers. The containers behave like real servers. OS-level virtualization is commonly used in creating virtual hosting environments to allocate hardware resources among a large number of mutually distrusting users. It is also used, to a lesser extent, in consolidating server hardware by moving services on separate hosts into containers or VMs on one server. OS-level virtualization is depicted in [Section 3.1.3](#).

3.1.1.4 Library Support Level

Most applications use APIs exported by user-level libraries rather than using lengthy system calls by the OS. Since most systems provide well-documented APIs, such an interface becomes another candidate for virtualization. Virtualization with library interfaces is possible by controlling the communication link between applications and the rest of a system through API hooks. The software tool WINE has implemented this approach to support Windows applications on top of UNIX hosts. Another example is the vCUDA which allows applications executing within VMs to leverage GPU hardware acceleration. This approach is detailed in [Section 3.1.4](#).

3.1.1.5 User-Application Level

Virtualization at the application level virtualizes an application as a VM. On a traditional OS, an application often runs as a process. Therefore, *application-level virtualization* is also known as

process-level virtualization. The most popular approach is to deploy *high level language (HLL)* VMs. In this scenario, the virtualization layer sits as an application program on top of the operating system, and the layer exports an abstraction of a VM that can run programs written and compiled to a particular abstract machine definition. Any program written in the HLL and compiled for this VM will be able to run on it. The Microsoft .NET CLR and *Java Virtual Machine (JVM)* are two good examples of this class of VM.

Other forms of application-level virtualization are known as *application isolation*, *application sandboxing*, or *application streaming*. The process involves wrapping the application in a layer that is isolated from the host OS and other applications. The result is an application that is much easier to distribute and remove from user workstations. An example is the LANDesk application virtualization platform which deploys software applications as self-contained, executable files in an isolated environment without requiring installation, system modifications, or elevated security privileges.

3.1.1.6 Relative Merits of Different Approaches

Table 3.1 compares the relative merits of implementing virtualization at various levels. The column headings correspond to four technical merits. “Higher Performance” and “Application Flexibility” are self-explanatory. “Implementation Complexity” implies the cost to implement that particular virtualization level. “Application Isolation” refers to the effort required to isolate resources committed to different VMs. Each row corresponds to a particular level of virtualization.

The number of X’s in the table cells reflects the advantage points of each implementation level. Five X’s implies the best case and one X implies the worst case. Overall, hardware and OS support will yield the highest performance. However, the hardware and application levels are also the most expensive to implement. User isolation is the most difficult to achieve. ISA implementation offers the best application flexibility.

3.1.2 VMM Design Requirements and Providers

As mentioned earlier, hardware-level virtualization inserts a layer between real hardware and traditional operating systems. This layer is commonly called the *Virtual Machine Monitor (VMM)* and it manages the hardware resources of a computing system. Each time programs access the hardware the VMM captures the process. In this sense, the VMM acts as a traditional OS. One hardware component, such as the CPU, can be virtualized as several virtual copies. Therefore, several traditional operating systems which are the same or different can sit on the same set of hardware simultaneously.

Level of Implementation	Higher Performance	Application Flexibility	Implementation Complexity	Application Isolation
ISA	X	XXXXX	XXX	XXX
Hardware-level virtualization	XXXXX	XXX	XXXXX	XXXX
OS-level virtualization	XXXXX	XX	XXX	XX
Runtime library support	XXX	XX	XX	XX
User application level	XX	XX	XXXXX	XXXXX

There are three requirements for a VMM. First, a VMM should provide an environment for programs which is essentially identical to the original machine. Second, programs run in this environment should show, at worst, only minor decreases in speed. Third, a VMM should be in complete control of the system resources. Any program run under a VMM should exhibit a function identical to that which it runs on the original machine directly. Two possible exceptions in terms of differences are permitted with this requirement: differences caused by the availability of system resources and differences caused by timing dependencies. The former arises when more than one VM is running on the same machine.

The hardware resource requirements, such as memory, of each VM are reduced, but the sum of them is greater than that of the real machine installed. The latter qualification is required because of the intervening level of software and the effect of any other VMs concurrently existing on the same hardware. Obviously, these two differences pertain to performance, while the function a VMM provides stays the same as that of a real machine. However, the identical environment requirement excludes the behavior of the usual time-sharing operating system from being classed as a VMM.

A VMM should demonstrate efficiency in using the VMs. Compared with a physical machine, no one prefers a VMM if its efficiency is too low. Traditional emulators and complete software interpreters (simulators) emulate each instruction by means of functions or macros. Such a method provides the most flexible solutions for VMMs. However, emulators or simulators are too slow to be used as real machines. To guarantee the efficiency of a VMM, a statistically dominant subset of the virtual processor's instructions needs to be executed directly by the real processor, with no software intervention by the VMM. Table 3.2 compares four hypervisors and VMMs that are in use today.

Complete control of these resources by a VMM includes the following aspects: (1) The VMM is responsible for allocating hardware resources for programs; (2) it is not possible for a program to access any resource not explicitly allocated to it; and (3) it is possible under certain circumstances for a VMM to regain control of resources already allocated. Not all processors satisfy these requirements for a VMM. A VMM is tightly related to the architectures of processors. It is difficult to

Provider and References	Host CPU	Host OS	Guest OS	Architecture
VMware Workstation [71]	x86, x86-64	Windows, Linux	Windows, Linux, Solaris, FreeBSD, Netware, OS/2, SCO, BeOS, Darwin	Full Virtualization
VMware ESX Server [71]	x86, x86-64	No host OS	The same as VMware Workstation	Para-Virtualization
Xen [7,13,42]	x86, x86-64, IA-64	NetBSD, Linux, Solaris	FreeBSD, NetBSD, Linux, Solaris, Windows XP and 2003 Server	Hypervisor
KVM [31]	x86, x86-64, IA-64, S390, PowerPC	Linux	Linux, Windows, FreeBSD, Solaris	Para-Virtualization

implement a VMM for some types of processors, such as the x86. Specific limitations include the inability to trap on some privileged instructions. If a processor is not designed to support virtualization primarily, it is necessary to modify the hardware to satisfy the three requirements for a VMM. This is known as hardware-assisted virtualization.

3.1.3 Virtualization Support at the OS Level

With the help of VM technology, a new computing mode known as cloud computing is emerging. Cloud computing is transforming the computing landscape by shifting the hardware and staffing costs of managing a computational center to third parties, just like banks. However, cloud computing has at least two challenges. The first is the ability to use a variable number of physical machines and VM instances depending on the needs of a problem. For example, a task may need only a single CPU during some phases of execution but may need hundreds of CPUs at other times. The second challenge concerns the slow operation of instantiating new VMs. Currently, new VMs originate either as fresh boots or as replicates of a template VM, unaware of the current application state. Therefore, to better support cloud computing, a large amount of research and development should be done.

3.1.3.1 Why OS-Level Virtualization?

As mentioned earlier, it is slow to initialize a hardware-level VM because each VM creates its own image from scratch. In a cloud computing environment, perhaps thousands of VMs need to be initialized simultaneously. Besides slow operation, storing the VM images also becomes an issue. As a matter of fact, there is considerable repeated content among VM images. Moreover, full virtualization at the hardware level also has the disadvantages of slow performance and low density, and the need for para-virtualization to modify the guest OS. To reduce the performance overhead of hardware-level virtualization, even hardware modification is needed. OS-level virtualization provides a feasible solution for these hardware-level virtualization issues.

Operating system virtualization inserts a virtualization layer inside an operating system to partition a machine's physical resources. It enables multiple isolated VMs within a single operating system kernel. This kind of VM is often called a *virtual execution environment (VE)*, *Virtual Private System (VPS)*, or simply *container*. From the user's point of view, VEs look like real servers. This means a VE has its own set of processes, file system, user accounts, network interfaces with IP addresses, routing tables, firewall rules, and other personal settings. Although VEs can be customized for different people, they share the same operating system kernel. Therefore, OS-level virtualization is also called single-OS image virtualization. [Figure 3.3](#) illustrates operating system virtualization from the point of view of a machine stack.

3.1.3.2 Advantages of OS Extensions

Compared to hardware-level virtualization, the benefits of OS extensions are twofold: (1) VMs at the operating system level have minimal startup/shutdown costs, low resource requirements, and high scalability; and (2) for an OS-level VM, it is possible for a VM and its host environment to synchronize state changes when necessary. These benefits can be achieved via two mechanisms of OS-level virtualization: (1) All OS-level VMs on the same physical machine share a single operating system kernel; and (2) the virtualization layer can be designed in a way that allows processes in VMs to access as many resources of the host machine as possible, but never to modify them. In cloud

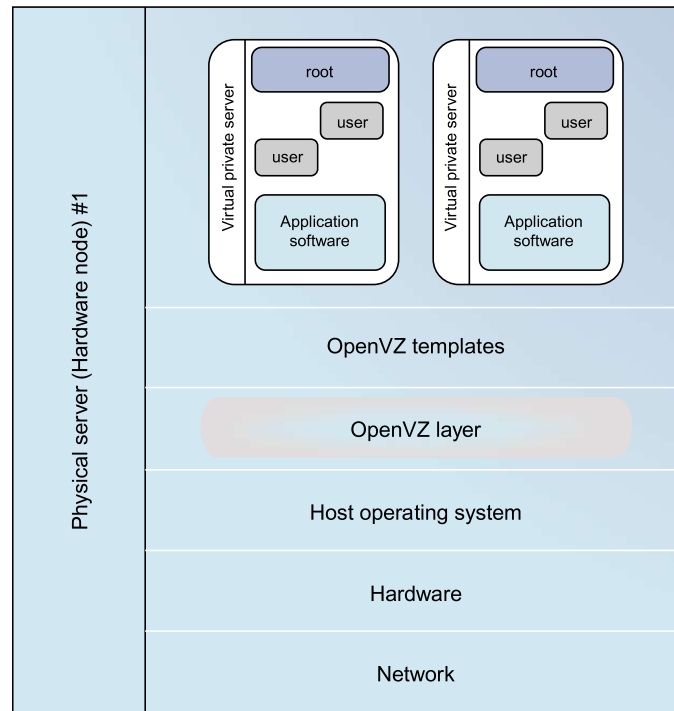
**FIGURE 3.3**

The OpenVZ virtualization layer inside the host OS, which provides some OS images to create VMs quickly.

(Courtesy of OpenVZ User's Guide [65])

computing, the first and second benefits can be used to overcome the defects of slow initialization of VMs at the hardware level, and being unaware of the current application state, respectively.

3.1.3.3 Disadvantages of OS Extensions

The main disadvantage of OS extensions is that all the VMs at operating system level on a single container must have the same kind of guest operating system. That is, although different OS-level VMs may have different operating system distributions, they must pertain to the same operating system family. For example, a Windows distribution such as Windows XP cannot run on a Linux-based container. However, users of cloud computing have various preferences. Some prefer Windows and others prefer Linux or other operating systems. Therefore, there is a challenge for OS-level virtualization in such cases.

Figure 3.3 illustrates the concept of OS-level virtualization. The virtualization layer is inserted inside the OS to partition the hardware resources for multiple VMs to run their applications in multiple virtual environments. To implement OS-level virtualization, isolated execution environments (VMs) should be created based on a single OS kernel. Furthermore, the access requests from a VM need to be redirected to the VM's local resource partition on the physical machine. For

example, the *chroot* command in a UNIX system can create several virtual root directories within a host OS. These virtual root directories are the root directories of all VMs created.

There are two ways to implement virtual root directories: duplicating common resources to each VM partition; or sharing most resources with the host environment and only creating private resource copies on the VM on demand. The first way incurs significant resource costs and overhead on a physical machine. This issue neutralizes the benefits of OS-level virtualization, compared with hardware-assisted virtualization. Therefore, OS-level virtualization is often a second choice.

3.1.3.4 Virtualization on Linux or Windows Platforms

By far, most reported OS-level virtualization systems are Linux-based. Virtualization support on the Windows-based platform is still in the research stage. The Linux kernel offers an abstraction layer to allow software processes to work with and operate on resources without knowing the hardware details. New hardware may need a new Linux kernel to support. Therefore, different Linux platforms use patched kernels to provide special support for extended functionality.

However, most Linux platforms are not tied to a special kernel. In such a case, a host can run several VMs simultaneously on the same hardware. Table 3.3 summarizes several examples of OS-level virtualization tools that have been developed in recent years. Two OS tools (Linux vServer and OpenVZ) support Linux platforms to run other platform-based applications through virtualization. These two OS-level tools are illustrated in Example 3.1. The third tool, FVM, is an attempt specifically developed for virtualization on the Windows NT platform.

Example 3.1 Virtualization Support for the Linux Platform

OpenVZ is an OS-level tool designed to support Linux platforms to create virtual environments for running VMs under different guest OSes. OpenVZ is an open source container-based virtualization solution built on Linux. To support virtualization and isolation of various subsystems, limited resource management, and checkpointing, OpenVZ modifies the Linux kernel. The overall picture of the OpenVZ system is illustrated in Figure 3.3. Several VPSes can run simultaneously on a physical machine. These VPSes look like normal

Virtualization Support and Source of Information	Brief Introduction on Functionality and Application Platforms
Linux vServer for Linux platforms (http://linux-vserver.org/)	Extends Linux kernels to implement a security mechanism to help build VMs by setting resource limits and file attributes and changing the root environment for VM isolation
OpenVZ for Linux platforms [65]; http://ftp.openvz.org/doc/OpenVZ-Users-Guide.pdf	Supports virtualization by creating <i>virtual private servers</i> (VPSes); the VPS has its own files, users, process tree, and virtual devices, which can be isolated from other VPSes, and checkpointing and live migration are supported
FVM (Feather-Weight Virtual Machines) for virtualizing the Windows NT platforms [78]	Uses system call interfaces to create VMs at the NT kernel space; multiple VMs are supported by virtualized namespace and copy-on-write

Linux servers. Each VPS has its own files, users and groups, process tree, virtual network, virtual devices, and IPC through semaphores and messages.

The resource management subsystem of OpenVZ consists of three components: two-level disk allocation, a two-level CPU scheduler, and a resource controller. The amount of disk space a VM can use is set by the OpenVZ server administrator. This is the first level of disk allocation. Each VM acts as a standard Linux system. Hence, the VM administrator is responsible for allocating disk space for each user and group. This is the second-level disk quota. The first-level CPU scheduler of OpenVZ decides which VM to give the time slice to, taking into account the virtual CPU priority and limit settings.

The second-level CPU scheduler is the same as that of Linux. OpenVZ has a set of about 20 parameters which are carefully chosen to cover all aspects of VM operation. Therefore, the resources that a VM can use are well controlled. OpenVZ also supports checkpointing and live migration. The complete state of a VM can quickly be saved to a disk file. This file can then be transferred to another physical machine and the VM can be restored there. It only takes a few seconds to complete the whole process. However, there is still a delay in processing because the established network connections are also migrated.

3.1.4 Middleware Support for Virtualization

Library-level virtualization is also known as user-level *Application Binary Interface (ABI)* or API emulation. This type of virtualization can create execution environments for running alien programs on a platform rather than creating a VM to run the entire operating system. API call interception and remapping are the key functions performed. This section provides an overview of several library-level virtualization systems: namely the *Windows Application Binary Interface (WABI)*, *lxc*, *WINE*, *Visual MainWin*, and *vCUDA*, which are summarized in [Table 3.4](#).

Middleware or Runtime Library and References or Web Link	Brief Introduction and Application Platforms
WABI (http://docs.sun.com/app/docs/doc/802-6306)	Middleware that converts Windows system calls running on x86 PCs to Solaris system calls running on SPARC workstations
Lxc (Linux Run) (http://www.ugcs.caltech.edu/~steven/lxc/)	A system call emulator that enables Linux applications written for x86 hosts to run on UNIX systems such as the SCO OpenServer
WINE (http://www.winehq.org/)	A library support system for virtualizing x86 processors to run Windows applications under Linux, FreeBSD, and Solaris
Visual MainWin (http://www.mainsoft.com/)	A compiler support system to develop Windows applications using Visual Studio to run on Solaris, Linux, and AIX hosts
vCUDA (Example 3.2) (IEEE <i>IPDPS</i> 2009 [57])	Virtualization support for using general-purpose GPUs to run data-intensive applications under a special guest OS

The WABI offers middleware to convert Windows system calls to Solaris system calls. Lxrun is really a system call emulator that enables Linux applications written for x86 hosts to run on UNIX systems. Similarly, Wine offers library support for virtualizing x86 processors to run Windows applications on UNIX hosts. Visual MainWin offers a compiler support system to develop Windows applications using Visual Studio to run on some UNIX hosts. The vCUDA is explained in [Example 3.2](#) with a graphical illustration in [Figure 3.4](#).

Example 3.2 The vCUDA for Virtualization of General-Purpose GPUs

CUDA is a programming model and library for general-purpose GPUs. It leverages the high performance of GPUs to run compute-intensive applications on host operating systems. However, it is difficult to run CUDA applications on hardware-level VMs directly. vCUDA virtualizes the CUDA library and can be installed on guest OSes. When CUDA applications run on a guest OS and issue a call to the CUDA API, vCUDA intercepts the call and redirects it to the CUDA API running on the host OS. [Figure 3.4](#) shows the basic concept of the vCUDA architecture [57].

The vCUDA employs a client-server model to implement CUDA virtualization. It consists of three user space components: the vCUDA library, a virtual GPU in the guest OS (which acts as a client), and the vCUDA stub in the host OS (which acts as a server). The vCUDA library resides in the guest OS as a substitute for the standard CUDA library. It is responsible for intercepting and redirecting API calls from the client to the stub. Besides these tasks, vCUDA also creates vGPUs and manages them.

The functionality of a vGPU is threefold: It abstracts the GPU structure and gives applications a uniform view of the underlying hardware; when a CUDA application in the guest OS allocates a device's memory the vGPU can return a local virtual address to the application and notify the remote stub to allocate the real device memory, and the vGPU is responsible for storing the CUDA API flow. The vCUDA stub receives

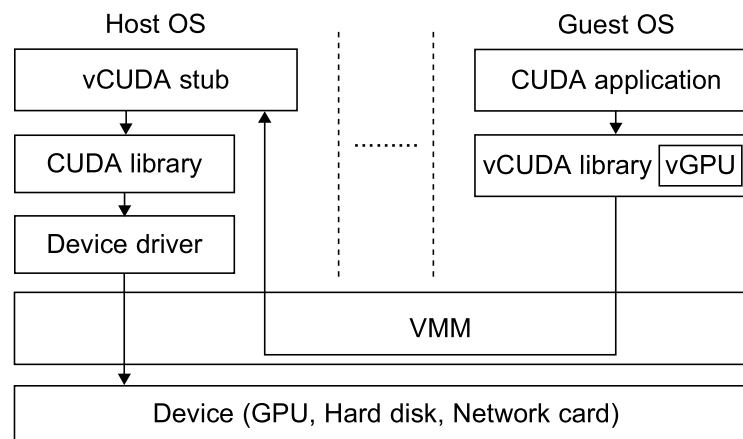

FIGURE 3.4

Basic concept of the vCUDA architecture.

(Courtesy of Lin Shi, et al. © IEEE [57])

and interprets remote requests and creates a corresponding execution context for the API calls from the guest OS, then returns the results to the guest OS. The vCUDA stub also manages actual physical resource allocation.

3.2 VIRTUALIZATION STRUCTURES/TOOLS AND MECHANISMS

In general, there are three typical classes of VM architecture. Figure 3.1 showed the architectures of a machine before and after virtualization. Before virtualization, the operating system manages the hardware. After virtualization, a virtualization layer is inserted between the hardware and the operating system. In such a case, the virtualization layer is responsible for converting portions of the real hardware into virtual hardware. Therefore, different operating systems such as Linux and Windows can run on the same physical machine, simultaneously. Depending on the position of the virtualization layer, there are several classes of VM architectures, namely the *hypervisor* architecture, *para-virtualization*, and *host-based virtualization*. The *hypervisor* is also known as the VMM (*Virtual Machine Monitor*). They both perform the same virtualization operations.

3.2.1 Hypervisor and Xen Architecture

The hypervisor supports hardware-level virtualization (see Figure 3.1(b)) on bare metal devices like CPU, memory, disk and network interfaces. The hypervisor software sits directly between the physical hardware and its OS. This virtualization layer is referred to as either the VMM or the hypervisor. The hypervisor provides *hypercalls* for the guest OSes and applications. Depending on the functionality, a hypervisor can assume a *micro-kernel architecture* like the Microsoft Hyper-V. Or it can assume a *monolithic hypervisor architecture* like the VMware ESX for server virtualization.

A micro-kernel hypervisor includes only the basic and unchanging functions (such as physical memory management and processor scheduling). The device drivers and other changeable components are outside the hypervisor. A monolithic hypervisor implements all the aforementioned functions, including those of the device drivers. Therefore, the size of the hypervisor code of a micro-kernel hypervisor is smaller than that of a monolithic hypervisor. Essentially, a hypervisor must be able to convert physical devices into virtual resources dedicated for the deployed VM to use.

3.2.1.1 The Xen Architecture

Xen is an open source hypervisor program developed by Cambridge University. Xen is a micro-kernel hypervisor, which separates the policy from the mechanism. The Xen hypervisor implements all the mechanisms, leaving the policy to be handled by Domain 0, as shown in Figure 3.5. Xen does not include any device drivers natively [7]. It just provides a mechanism by which a guest OS can have direct access to the physical devices. As a result, the size of the Xen hypervisor is kept rather small. Xen provides a virtual environment located between the hardware and the OS. A number of vendors are in the process of developing commercial Xen hypervisors, among them are Citrix XenServer [62] and Oracle VM [42].

The core components of a Xen system are the hypervisor, kernel, and applications. The organization of the three components is important. Like other virtualization systems, many guest OSes can run on top of the hypervisor. However, not all guest OSes are created equal, and one in

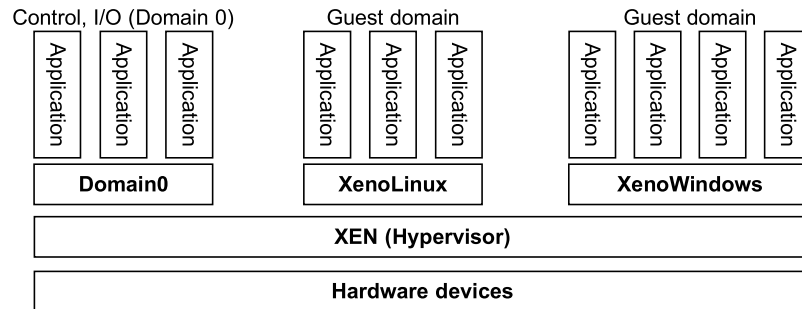

FIGURE 3.5

The Xen architecture's special domain 0 for control and I/O, and several guest domains for user applications.

(Courtesy of P. Barham, et al. [7])

particular controls the others. The guest OS, which has control ability, is called Domain 0, and the others are called Domain U. Domain 0 is a privileged guest OS of Xen. It is first loaded when Xen boots without any file system drivers being available. Domain 0 is designed to access hardware directly and manage devices. Therefore, one of the responsibilities of Domain 0 is to allocate and map hardware resources for the guest domains (the Domain U domains).

For example, Xen is based on Linux and its security level is C2. Its management VM is named Domain 0, which has the privilege to manage other VMs implemented on the same host. If Domain 0 is compromised, the hacker can control the entire system. So, in the VM system, security policies are needed to improve the security of Domain 0. Domain 0, behaving as a VMM, allows users to create, copy, save, read, modify, share, migrate, and roll back VMs as easily as manipulating a file, which flexibly provides tremendous benefits for users. Unfortunately, it also brings a series of security problems during the software life cycle and data lifetime.

Traditionally, a machine's lifetime can be envisioned as a straight line where the current state of the machine is a point that progresses monotonically as the software executes. During this time, configuration changes are made, software is installed, and patches are applied. In such an environment, the VM state is akin to a tree: At any point, execution can go into N different branches where multiple instances of a VM can exist at any point in this tree at any given time. VMs are allowed to roll back to previous states in their execution (e.g., to fix configuration errors) or rerun from the same point many times (e.g., as a means of distributing dynamic content or circulating a "live" system image).

3.2.2 Binary Translation with Full Virtualization

Depending on implementation technologies, hardware virtualization can be classified into two categories: *full virtualization* and *host-based virtualization*. Full virtualization does not need to modify the host OS. It relies on *binary translation* to trap and to virtualize the execution of certain sensitive, nonvirtualizable instructions. The guest OSes and their applications consist of noncritical and critical instructions. In a host-based system, both a host OS and a guest OS are used. A virtualization software layer is built between the host OS and guest OS. These two classes of VM architecture are introduced next.

3.2.2.1 Full Virtualization

With full virtualization, noncritical instructions run on the hardware directly while critical instructions are discovered and replaced with traps into the VMM to be emulated by software. Both the hypervisor and VMM approaches are considered full virtualization. Why are only critical instructions trapped into the VMM? This is because binary translation can incur a large performance overhead. Noncritical instructions do not control hardware or threaten the security of the system, but critical instructions do. Therefore, running noncritical instructions on hardware not only can promote efficiency, but also can ensure system security.

3.2.2.2 Binary Translation of Guest OS Requests Using a VMM

This approach was implemented by VMware and many other software companies. As shown in Figure 3.6, VMware puts the VMM at Ring 0 and the guest OS at Ring 1. The VMM scans the instruction stream and identifies the privileged, control- and behavior-sensitive instructions. When these instructions are identified, they are trapped into the VMM, which emulates the behavior of these instructions. The method used in this emulation is called *binary translation*. Therefore, full virtualization combines binary translation and direct execution. The guest OS is completely decoupled from the underlying hardware. Consequently, the guest OS is unaware that it is being virtualized.

The performance of full virtualization may not be ideal, because it involves binary translation which is rather time-consuming. In particular, the full virtualization of I/O-intensive applications is a really a big challenge. Binary translation employs a code cache to store translated hot instructions to improve performance, but it increases the cost of memory usage. At the time of this writing, the performance of full virtualization on the x86 architecture is typically 80 percent to 97 percent that of the host machine.

3.2.2.3 Host-Based Virtualization

An alternative VM architecture is to install a virtualization layer on top of the host OS. This host OS is still responsible for managing the hardware. The guest OSES are installed and run on top of the virtualization layer. Dedicated applications may run on the VMs. Certainly, some other applications can also run with the host OS directly. This host-based architecture has some distinct advantages, as enumerated next. First, the user can install this VM architecture without modifying the host OS. The virtualizing software can rely on the host OS to provide device drivers and other low-level services. This will simplify the VM design and ease its deployment.

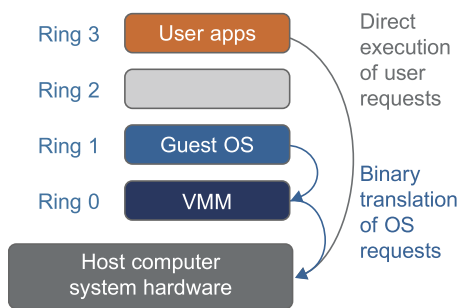

FIGURE 3.6

Indirect execution of complex instructions via binary translation of guest OS requests using the VMM plus direct execution of simple instructions on the same host.

(Courtesy of VM Ware [71])

Second, the host-based approach appeals to many host machine configurations. Compared to the hypervisor/VMM architecture, the performance of the host-based architecture may also be low. When an application requests hardware access, it involves four layers of mapping which downgrades performance significantly. When the ISA of a guest OS is different from the ISA of

the underlying hardware, binary translation must be adopted. Although the host-based architecture has flexibility, the performance is too low to be useful in practice.

3.2.3 Para-Virtualization with Compiler Support

Para-virtualization needs to modify the guest operating systems. A para-virtualized VM provides special APIs requiring substantial OS modifications in user applications. Performance degradation is a critical issue of a virtualized system. No one wants to use a VM if it is much slower than using a physical machine. The virtualization layer can be inserted at different positions in a machine software stack. However, para-virtualization attempts to reduce the virtualization overhead, and thus improve performance by modifying only the guest OS kernel.

Figure 3.7 illustrates the concept of a para-virtualized VM architecture. The guest operating systems are para-virtualized. They are assisted by an intelligent compiler to replace the nonvirtualizable OS instructions by hypercalls as illustrated in Figure 3.8. The traditional x86 processor offers four instruction execution rings: Rings 0, 1, 2, and 3. The lower the ring number, the higher the privilege of instruction being executed. The OS is responsible for managing the hardware and the privileged instructions to execute at Ring 0, while user-level applications run at Ring 3. The best example of para-virtualization is the KVM to be described below.

3.2.3.1 Para-Virtualization Architecture

When the x86 processor is virtualized, a virtualization layer is inserted between the hardware and the OS. According to the x86 ring definition, the virtualization layer should also be installed at Ring 0. Different instructions at Ring 0 may cause some problems. In Figure 3.8, we show that para-virtualization replaces nonvirtualizable instructions with *hypercalls* that communicate directly with the hypervisor or VMM. However, when the guest OS kernel is modified for virtualization, it can no longer run on the hardware directly.

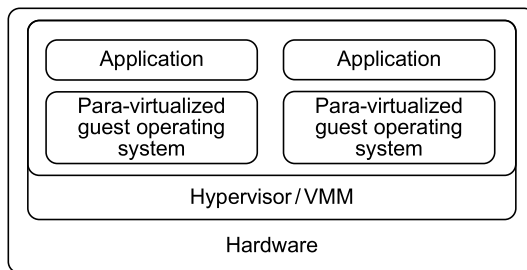

FIGURE 3.7

Para-virtualized VM architecture, which involves modifying the guest OS kernel to replace nonvirtualizable instructions with hypercalls for the hypervisor or the VMM to carry out the virtualization process (See Figure 3.8 for more details.)

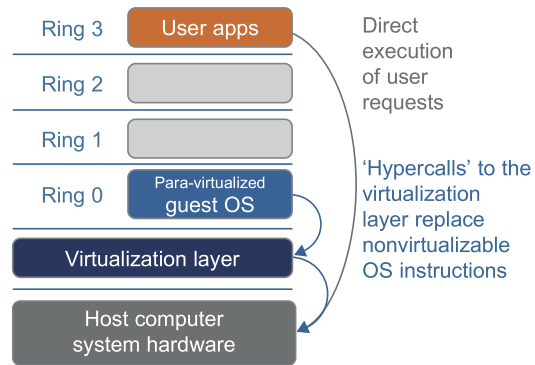

FIGURE 3.8

The use of a para-virtualized guest OS assisted by an intelligent compiler to replace nonvirtualizable OS instructions by hypercalls.

(Courtesy of VMware [71])

Although para-virtualization reduces the overhead, it has incurred other problems. First, its compatibility and portability may be in doubt, because it must support the unmodified OS as well. Second, the cost of maintaining para-virtualized OSes is high, because they may require deep OS kernel modifications. Finally, the performance advantage of para-virtualization varies greatly due to workload variations. Compared with full virtualization, para-virtualization is relatively easy and more practical. The main problem in full virtualization is its low performance in binary translation. To speed up binary translation is difficult. Therefore, many virtualization products employ the para-virtualization architecture. The popular Xen, KVM, and VMware ESX are good examples.

3.2.3.2 KVM (Kernel-Based VM)

This is a Linux para-virtualization system—a part of the Linux version 2.6.20 kernel. Memory management and scheduling activities are carried out by the existing Linux kernel. The KVM does the rest, which makes it simpler than the hypervisor that controls the entire machine. KVM is a hardware-assisted para-virtualization tool, which improves performance and supports unmodified guest OSes such as Windows, Linux, Solaris, and other UNIX variants.

3.2.3.3 Para-Virtualization with Compiler Support

Unlike the full virtualization architecture which intercepts and emulates privileged and sensitive instructions at runtime, para-virtualization handles these instructions at compile time. The guest OS kernel is modified to replace the privileged and sensitive instructions with hypercalls to the hypervisor or VMM. Xen assumes such a para-virtualization architecture.

The guest OS running in a guest domain may run at Ring 1 instead of at Ring 0. This implies that the guest OS may not be able to execute some privileged and sensitive instructions. The privileged instructions are implemented by hypercalls to the hypervisor. After replacing the instructions with hypercalls, the modified guest OS emulates the behavior of the original guest OS. On an UNIX system, a system call involves an interrupt or service routine. The hypercalls apply a dedicated service routine in Xen.

Example 3.3 VMware ESX Server for Para-Virtualization

VMware pioneered the software market for virtualization. The company has developed virtualization tools for desktop systems and servers as well as virtual infrastructure for large data centers. ESX is a VMM or a hypervisor for bare-metal x86 symmetric multiprocessing (SMP) servers. It accesses hardware resources such as I/O directly and has complete resource management control. An ESX-enabled server consists of four components: a virtualization layer, a resource manager, hardware interface components, and a service console, as shown in [Figure 3.9](#). To improve performance, the ESX server employs a para-virtualization architecture in which the VM kernel interacts directly with the hardware without involving the host OS.

The VMM layer virtualizes the physical hardware resources such as CPU, memory, network and disk controllers, and human interface devices. Every VM has its own set of virtual hardware resources. The resource manager allocates CPU, memory disk, and network bandwidth and maps them to the virtual hardware resource set of each VM created. Hardware interface components are the device drivers and the

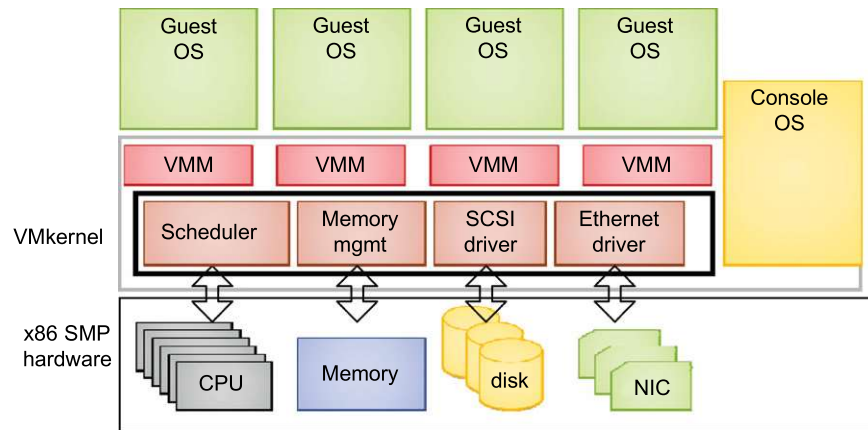
**FIGURE 3.9**

The VMware ESX server architecture using para-virtualization.

(Courtesy of VMware [71])

VMware ESX Server File System. The service console is responsible for booting the system, initiating the execution of the VMM and resource manager, and relinquishing control to those layers. It also facilitates the process for system administrators.

3.3 VIRTUALIZATION OF CPU, MEMORY, AND I/O DEVICES

To support virtualization, processors such as the x86 employ a special running mode and instructions, known as *hardware-assisted virtualization*. In this way, the VMM and guest OS run in different modes and all sensitive instructions of the guest OS and its applications are trapped in the VMM. To save processor states, mode switching is completed by hardware. For the x86 architecture, Intel and AMD have proprietary technologies for hardware-assisted virtualization.

3.3.1 Hardware Support for Virtualization

Modern operating systems and processors permit multiple processes to run simultaneously. If there is no protection mechanism in a processor, all instructions from different processes will access the hardware directly and cause a system crash. Therefore, all processors have at least two modes, user mode and supervisor mode, to ensure controlled access of critical hardware. Instructions running in supervisor mode are called privileged instructions. Other instructions are unprivileged instructions. In a virtualized environment, it is more difficult to make OSes and applications run correctly because there are more layers in the machine stack. [Example 3.4](#) discusses Intel's hardware support approach.

At the time of this writing, many hardware virtualization products were available. The VMware Workstation is a VM software suite for x86 and x86-64 computers. This software suite allows users to set up multiple x86 and x86-64 virtual computers and to use one or more of these VMs simultaneously with the host operating system. The VMware Workstation assumes the host-based virtualization. Xen is a hypervisor for use in IA-32, x86-64, Itanium, and PowerPC 970 hosts. Actually, Xen modifies Linux as the lowest and most privileged layer, or a hypervisor.

One or more guest OS can run on top of the hypervisor. KVM (*Kernel-based Virtual Machine*) is a Linux kernel virtualization infrastructure. KVM can support hardware-assisted virtualization and paravirtualization by using the Intel VT-x or AMD-v and VirtIO framework, respectively. The VirtIO framework includes a paravirtual Ethernet card, a disk I/O controller, a balloon device for adjusting guest memory usage, and a VGA graphics interface using VMware drivers.

Example 3.4 Hardware Support for Virtualization in the Intel x86 Processor

Since software-based virtualization techniques are complicated and incur performance overhead, Intel provides a hardware-assist technique to make virtualization easy and improve performance. Figure 3.10 provides an overview of Intel's full virtualization techniques. For processor virtualization, Intel offers the VT-x or VT-i technique. VT-x adds a privileged mode (VMX Root Mode) and some instructions to processors. This enhancement traps all sensitive instructions in the VMM automatically. For memory virtualization, Intel offers the EPT, which translates the virtual address to the machine's physical addresses to improve performance. For I/O virtualization, Intel implements VT-d and VT-c to support this.

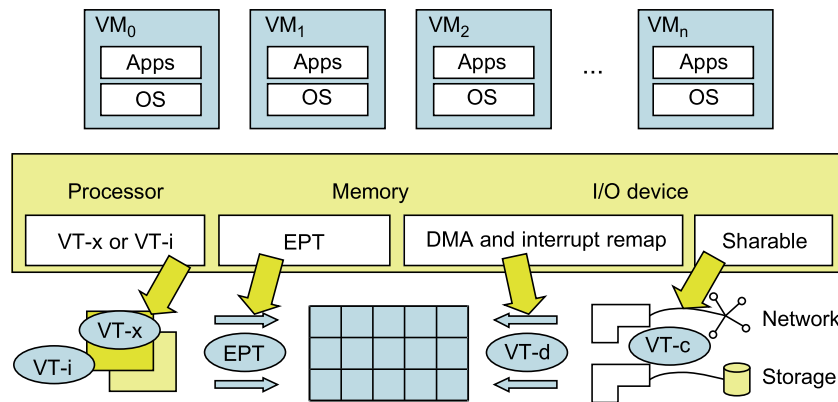

FIGURE 3.10

Intel hardware support for virtualization of processor, memory, and I/O devices.

(Modified from [68], Courtesy of Lizhong Chen, USC)

3.3.2 CPU Virtualization

A VM is a duplicate of an existing computer system in which a majority of the VM instructions are executed on the host processor in native mode. Thus, unprivileged instructions of VMs run directly on the host machine for higher efficiency. Other critical instructions should be handled carefully for correctness and stability. The critical instructions are divided into three categories: *privileged instructions*, *control-sensitive instructions*, and *behavior-sensitive instructions*. Privileged instructions execute in a privileged mode and will be trapped if executed outside this mode. Control-sensitive instructions attempt to change the configuration of resources used. Behavior-sensitive instructions have different behaviors depending on the configuration of resources, including the load and store operations over the virtual memory.

A CPU architecture is virtualizable if it supports the ability to run the VM's privileged and unprivileged instructions in the CPU's user mode while the VMM runs in supervisor mode. When the privileged instructions including control- and behavior-sensitive instructions of a VM are executed, they are trapped in the VMM. In this case, the VMM acts as a unified mediator for hardware access from different VMs to guarantee the correctness and stability of the whole system. However, not all CPU architectures are virtualizable. RISC CPU architectures can be naturally virtualized because all control- and behavior-sensitive instructions are privileged instructions. On the contrary, x86 CPU architectures are not primarily designed to support virtualization. This is because about 10 sensitive instructions, such as *SGDT* and *SMSW*, are not privileged instructions. When these instructions execute in virtualization, they cannot be trapped in the VMM.

On a native UNIX-like system, a system call triggers the *80h* interrupt and passes control to the OS kernel. The interrupt handler in the kernel is then invoked to process the system call. On a paravirtualization system such as Xen, a system call in the guest OS first triggers the *80h* interrupt normally. Almost at the same time, the *82h* interrupt in the hypervisor is triggered. Incidentally, control is passed on to the hypervisor as well. When the hypervisor completes its task for the guest OS system call, it passes control back to the guest OS kernel. Certainly, the guest OS kernel may also invoke the hypercall while it's running. Although paravirtualization of a CPU lets unmodified applications run in the VM, it causes a small performance penalty.

3.3.2.1 Hardware-Assisted CPU Virtualization

This technique attempts to simplify virtualization because full or paravirtualization is complicated. Intel and AMD add an additional mode called privilege mode level (some people call it Ring-1) to x86 processors. Therefore, operating systems can still run at Ring 0 and the hypervisor can run at Ring -1. All the privileged and sensitive instructions are trapped in the hypervisor automatically. This technique removes the difficulty of implementing binary translation of full virtualization. It also lets the operating system run in VMs without modification.

Example 3.5 Intel Hardware-Assisted CPU Virtualization

Although x86 processors are not virtualizable primarily, great effort is taken to virtualize them. They are used widely in comparing RISC processors that the bulk of x86-based legacy systems cannot discard easily. Virtualization of x86 processors is detailed in the following sections. Intel's VT-x technology is an example of hardware-assisted virtualization, as shown in [Figure 3.11](#). Intel calls the privilege level of x86 processors the VMX Root Mode. In order to control the start and stop of a VM and allocate a memory page to maintain the

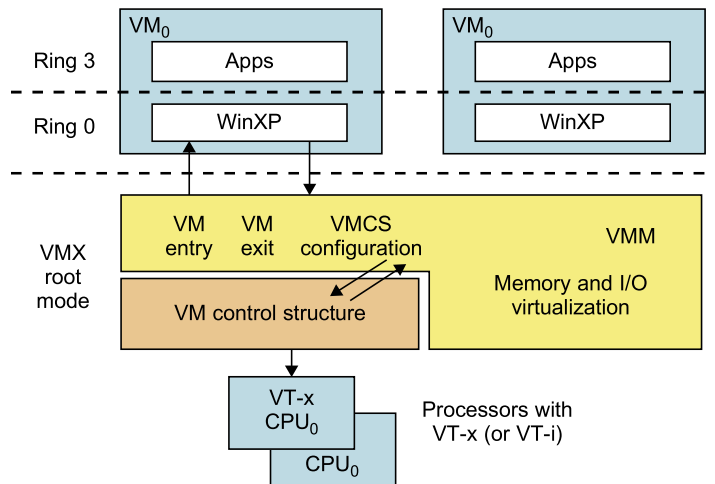
**FIGURE 3.11**

Intel hardware-assisted CPU virtualization.

(Modified from [68], Courtesy of Lizhong Chen, USC)

CPU state for VMs, a set of additional instructions is added. At the time of this writing, Xen, VMware, and the Microsoft Virtual PC all implement their hypervisors by using the VT-x technology.

Generally, hardware-assisted virtualization should have high efficiency. However, since the transition from the hypervisor to the guest OS incurs high overhead switches between processor modes, it sometimes cannot outperform binary translation. Hence, virtualization systems such as VMware now use a hybrid approach, in which a few tasks are offloaded to the hardware but the rest is still done in software. In addition, para-virtualization and hardware-assisted virtualization can be combined to improve the performance further.

3.3.3 Memory Virtualization

Virtual memory virtualization is similar to the virtual memory support provided by modern operating systems. In a traditional execution environment, the operating system maintains mappings of *virtual memory* to *machine memory* using page tables, which is a one-stage mapping from virtual memory to machine memory. All modern x86 CPUs include a *memory management unit (MMU)* and a *translation lookaside buffer (TLB)* to optimize virtual memory performance. However, in a virtual execution environment, virtual memory virtualization involves sharing the physical system memory in RAM and dynamically allocating it to the *physical memory* of the VMs.

That means a two-stage mapping process should be maintained by the guest OS and the VMM, respectively: virtual memory to physical memory and physical memory to machine memory. Furthermore, MMU virtualization should be supported, which is transparent to the guest OS. The guest OS continues to control the mapping of virtual addresses to the physical memory addresses of VMs. But the guest OS cannot directly access the actual machine memory. The VMM is responsible for mapping the guest physical memory to the actual machine memory. Figure 3.12 shows the two-level memory mapping procedure.

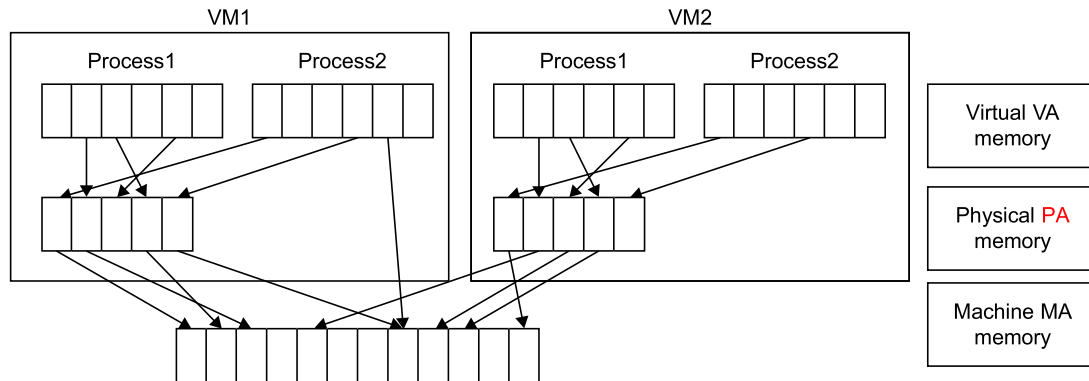

FIGURE 3.12

Two-level memory mapping procedure.

(Courtesy of R. Rblig, et al. [68])

Since each page table of the guest OSes has a separate page table in the VMM corresponding to it, the VMM page table is called the shadow page table. Nested page tables add another layer of indirection to virtual memory. The MMU already handles virtual-to-physical translations as defined by the OS. Then the physical memory addresses are translated to machine addresses using another set of page tables defined by the hypervisor. Since modern operating systems maintain a set of page tables for every process, the shadow page tables will get flooded. Consequently, the performance overhead and cost of memory will be very high.

VMware uses shadow page tables to perform virtual-memory-to-machine-memory address translation. Processors use TLB hardware to map the virtual memory directly to the machine memory to avoid the two levels of translation on every access. When the guest OS changes the virtual memory to a physical memory mapping, the VMM updates the shadow page tables to enable a direct lookup. The AMD Barcelona processor has featured hardware-assisted memory virtualization since 2007. It provides hardware assistance to the two-stage address translation in a virtual execution environment by using a technology called nested paging.

Example 3.6 Extended Page Table by Intel for Memory Virtualization

Since the efficiency of the software shadow page table technique was too low, Intel developed a hardware-based EPT technique to improve it, as illustrated in Figure 3.13. In addition, Intel offers a Virtual Processor ID (VPID) to improve use of the TLB. Therefore, the performance of memory virtualization is greatly improved. In Figure 3.13, the page tables of the guest OS and EPT are all four-level.

When a virtual address needs to be translated, the CPU will first look for the L4 page table pointed to by Guest CR3. Since the address in Guest CR3 is a physical address in the guest OS, the CPU needs to convert the Guest CR3 GPA to the host physical address (HPA) using EPT. In this procedure, the CPU will check the EPT TLB to see if the translation is there. If there is no required translation in the EPT TLB, the CPU will look for it in the EPT. If the CPU cannot find the translation in the EPT, an EPT violation exception will be raised.

When the GPA of the L4 page table is obtained, the CPU will calculate the GPA of the L3 page table by using the GVA and the content of the L4 page table. If the entry corresponding to the GVA in the L4

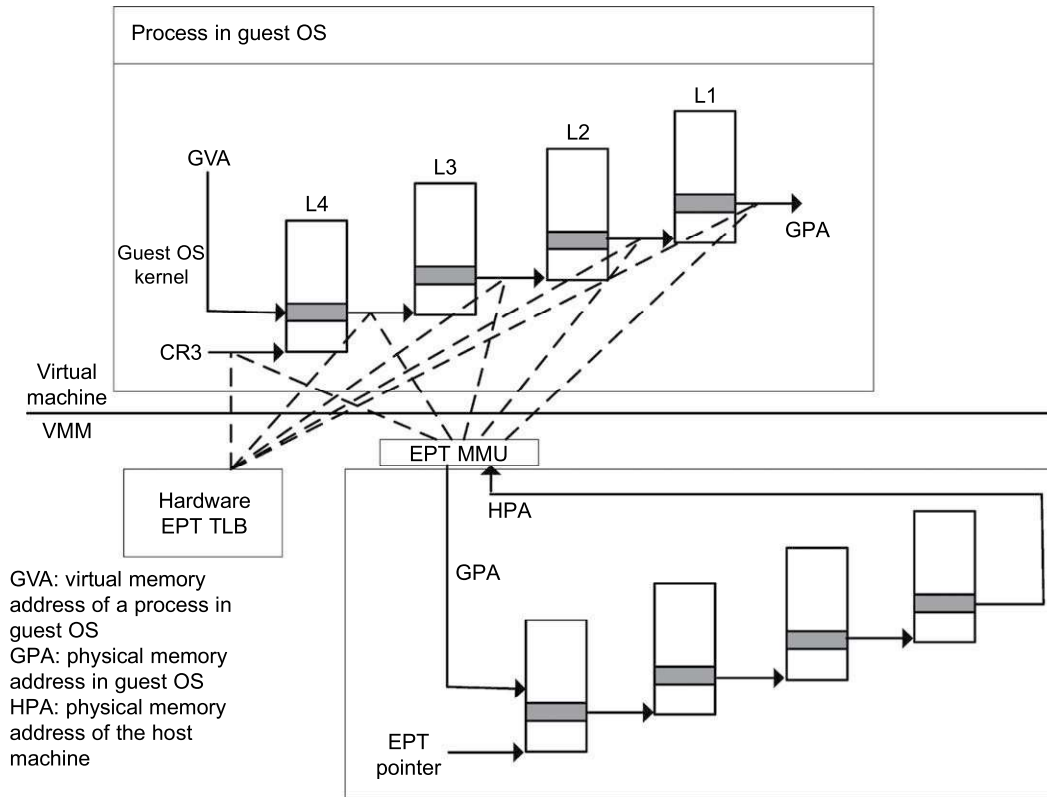
**FIGURE 3.13**

Memory virtualization using EPT by Intel (the EPT is also known as the shadow page table [68]).

page table is a page fault, the CPU will generate a page fault interrupt and will let the guest OS kernel handle the interrupt. When the PGA of the L3 page table is obtained, the CPU will look for the EPT to get the HPA of the L3 page table, as described earlier. To get the HPA corresponding to a GVA, the CPU needs to look for the EPT five times, and each time, the memory needs to be accessed four times. Therefore, there are 20 memory accesses in the worst case, which is still very slow. To overcome this shortcoming, Intel increased the size of the EPT TLB to decrease the number of memory accesses.

3.3.4 I/O Virtualization

I/O virtualization involves managing the routing of I/O requests between virtual devices and the shared physical hardware. At the time of this writing, there are three ways to implement I/O virtualization: full device emulation, para-virtualization, and direct I/O. Full device emulation is the first approach for I/O virtualization. Generally, this approach emulates well-known, real-world devices.

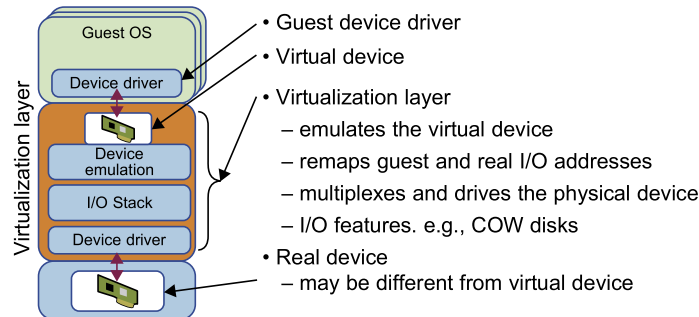
**FIGURE 3.14**

Device emulation for I/O virtualization implemented inside the middle layer that maps real I/O devices into the virtual devices for the guest device driver to use.

(Courtesy of V. Chadha, et al. [10] and Y. Dong, et al. [15])

All the functions of a device or bus infrastructure, such as device enumeration, identification, interrupts, and DMA, are replicated in software. This software is located in the VMM and acts as a virtual device. The I/O access requests of the guest OS are trapped in the VMM which interacts with the I/O devices. The full device emulation approach is shown in Figure 3.14.

A single hardware device can be shared by multiple VMs that run concurrently. However, software emulation runs much slower than the hardware it emulates [10,15]. The para-virtualization method of I/O virtualization is typically used in Xen. It is also known as the split driver model consisting of a frontend driver and a backend driver. The frontend driver is running in Domain U and the backend driver is running in Domain 0. They interact with each other via a block of shared memory. The frontend driver manages the I/O requests of the guest OSes and the backend driver is responsible for managing the real I/O devices and multiplexing the I/O data of different VMs. Although para-I/O-virtualization achieves better device performance than full device emulation, it comes with a higher CPU overhead.

Direct I/O virtualization lets the VM access devices directly. It can achieve close-to-native performance without high CPU costs. However, current direct I/O virtualization implementations focus on networking for mainframes. There are a lot of challenges for commodity hardware devices. For example, when a physical device is reclaimed (required by workload migration) for later reassignment, it may have been set to an arbitrary state (e.g., DMA to some arbitrary memory locations) that can function incorrectly or even crash the whole system. Since software-based I/O virtualization requires a very high overhead of device emulation, hardware-assisted I/O virtualization is critical. Intel VT-d supports the remapping of I/O DMA transfers and device-generated interrupts. The architecture of VT-d provides the flexibility to support multiple usage models that may run unmodified, special-purpose, or “virtualization-aware” guest OSes.

Another way to help I/O virtualization is via self-virtualized I/O (SV-IO) [47]. The key idea of SV-IO is to harness the rich resources of a multicore processor. All tasks associated with virtualizing an I/O device are encapsulated in SV-IO. It provides virtual devices and an associated access API to VMs and a management API to the VMM. SV-IO defines one virtual interface (VIF) for every kind of virtualized I/O device, such as virtual network interfaces, virtual block devices (disk), virtual camera devices,

and others. The guest OS interacts with the VIFs via VIF device drivers. Each VIF consists of two message queues. One is for outgoing messages to the devices and the other is for incoming messages from the devices. In addition, each VIF has a unique ID for identifying it in SV-IO.

Example 3.7 VMware Workstation for I/O Virtualization

The VMware Workstation runs as an application. It leverages the I/O device support in guest OSes, host OSes, and VMM to implement I/O virtualization. The application portion (VMAp) uses a driver loaded into the host operating system (VMDriver) to establish the privileged VMM, which runs directly on the hardware. A given physical processor is executed in either the host world or the VMM world, with the VMDriver facilitating the transfer of control between the two worlds. The VMware Workstation employs full device emulation to implement I/O virtualization. Figure 3.15 shows the functional blocks used in sending and receiving packets via the emulated virtual NIC.

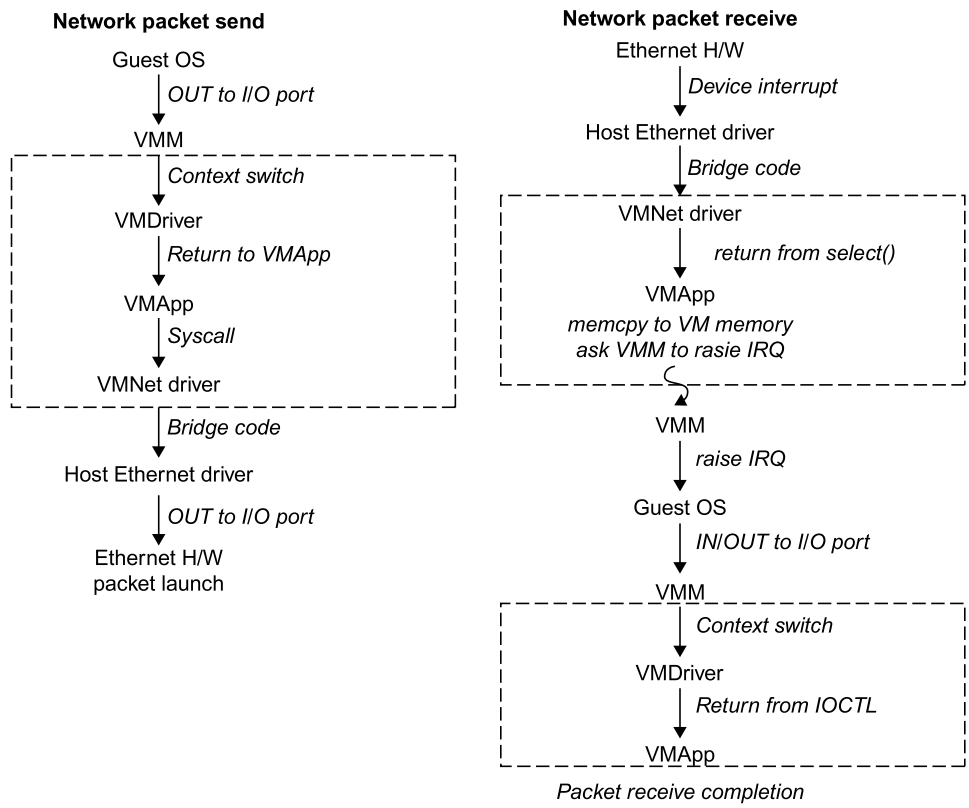

FIGURE 3.15

Functional blocks involved in sending and receiving network packets.

(Courtesy of VMWare [71])

The virtual NIC models an AMD Lance Am79C970A controller. The device driver for a Lance controller in the guest OS initiates packet transmissions by reading and writing a sequence of virtual I/O ports; each read or write switches back to the VMApp to emulate the Lance port accesses. When the last OUT instruction of the sequence is encountered, the Lance emulator calls a normal *write()* to the VMNet driver. The VMNet driver then passes the packet onto the network via a host NIC and then the VMApp switches back to the VMM. The switch raises a virtual interrupt to notify the guest device driver that the packet was sent. Packet receives occur in reverse.

3.3.5 Virtualization in Multi-Core Processors

Virtualizing a multi-core processor is relatively more complicated than virtualizing a uni-core processor. Though multicore processors are claimed to have higher performance by integrating multiple processor cores in a single chip, multi-core virtualization has raised some new challenges to computer architects, compiler constructors, system designers, and application programmers. There are mainly two difficulties: Application programs must be parallelized to use all cores fully, and software must explicitly assign tasks to the cores, which is a very complex problem.

Concerning the first challenge, new programming models, languages, and libraries are needed to make parallel programming easier. The second challenge has spawned research involving scheduling algorithms and resource management policies. Yet these efforts cannot balance well among performance, complexity, and other issues. What is worse, as technology scales, a new challenge called *dynamic heterogeneity* is emerging to mix the fat CPU core and thin GPU cores on the same chip, which further complicates the multi-core or many-core resource management. The dynamic heterogeneity of hardware infrastructure mainly comes from less reliable transistors and increased complexity in using the transistors [33,66].

3.3.5.1 Physical versus Virtual Processor Cores

Wells, et al. [74] proposed a multicore virtualization method to allow hardware designers to get an abstraction of the low-level details of the processor cores. This technique alleviates the burden and inefficiency of managing hardware resources by software. It is located under the ISA and remains unmodified by the operating system or VMM (hypervisor). Figure 3.16 illustrates the technique of a software-visible VCPU moving from one core to another and temporarily suspending execution of a VCPU when there are no appropriate cores on which it can run.

3.3.5.2 Virtual Hierarchy

The emerging many-core *chip multiprocessors* (CMPs) provides a new computing landscape. Instead of supporting time-sharing jobs on one or a few cores, we can use the abundant cores in a space-sharing, where single-threaded or multithreaded jobs are simultaneously assigned to separate groups of cores for long time intervals. This idea was originally suggested by Marty and Hill [39]. To optimize for space-shared workloads, they propose using *virtual hierarchies* to overlay a coherence and caching hierarchy onto a physical processor. Unlike a fixed physical hierarchy, a virtual hierarchy can adapt to fit how the work is space shared for improved performance and performance isolation.

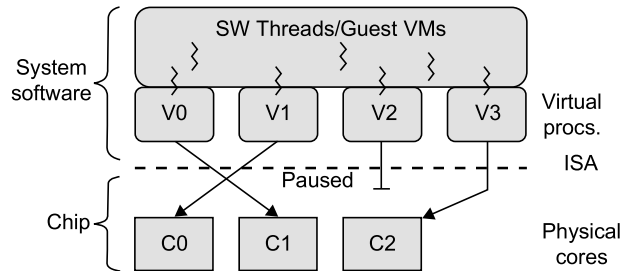
**FIGURE 3.16**

Multicore virtualization method that exposes four VCPUs to the software, when only three cores are actually present.

(Courtesy of Wells, et al. [74])

Today's many-core CMPs use a physical hierarchy of two or more cache levels that statically determine the cache allocation and mapping. A *virtual hierarchy* is a cache hierarchy that can adapt to fit the workload or mix of workloads [39]. The hierarchy's first level locates data blocks close to the cores needing them for faster access, establishes a shared-cache domain, and establishes a point of coherence for faster communication. When a miss leaves a tile, it first attempts to locate the block (or sharers) within the first level. The first level can also provide isolation between independent workloads. A miss at the L1 cache can invoke the L2 access.

The idea is illustrated in Figure 3.17(a). Space sharing is applied to assign three workloads to three clusters of virtual cores: namely VM0 and VM3 for database workload, VM1 and VM2 for web server workload, and VM4–VM7 for middleware workload. The basic assumption is that each workload runs in its own VM. However, space sharing applies equally within a single operating system. Statically distributing the directory among tiles can do much better, provided operating systems or hypervisors carefully map virtual pages to physical frames. Marty and Hill suggested a two-level virtual coherence and caching hierarchy that harmonizes with the assignment of tiles to the virtual clusters of VMs.

Figure 3.17(b) illustrates a logical view of such a virtual cluster hierarchy in two levels. Each VM operates in a isolated fashion at the first level. This will minimize both miss access time and performance interference with other workloads or VMs. Moreover, the shared resources of cache capacity, inter-connect links, and miss handling are mostly isolated between VMs. The second level maintains a globally shared memory. This facilitates dynamically repartitioning resources without costly cache flushes. Furthermore, maintaining globally shared memory minimizes changes to existing system software and allows virtualization features such as content-based page sharing. A virtual hierarchy adapts to space-shared workloads like multiprogramming and server consolidation. Figure 3.17 shows a case study focused on consolidated server workloads in a tiled architecture. This many-core mapping scheme can also optimize for space-shared multiprogrammed workloads in a single-OS environment.

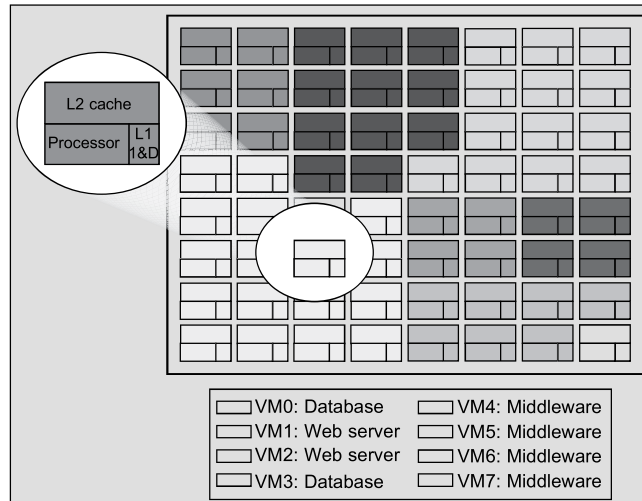

(a) Mapping of VMs into adjacent cores

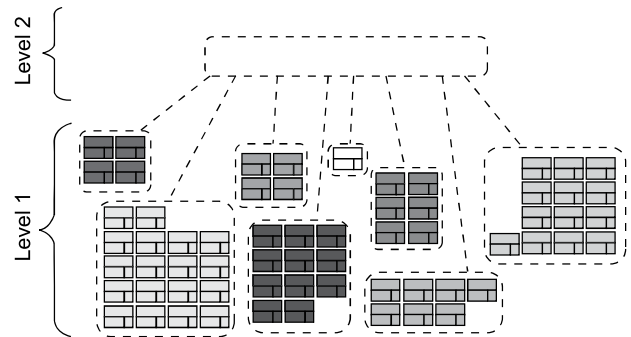

(b) Multiple virtual clusters assigned to various workloads

FIGURE 3.17

CMP server consolidation by space-sharing of VMs into many cores forming multiple virtual clusters to execute various workloads.

(Courtesy of Marty and Hill [39])

3.4 VIRTUAL CLUSTERS AND RESOURCE MANAGEMENT

A *physical cluster* is a collection of servers (physical machines) interconnected by a physical network such as a LAN. In [Chapter 2](#), we studied various clustering techniques on physical machines. Here, we introduce virtual clusters and study its properties as well as explore their potential applications. In this section, we will study three critical design issues of virtual clusters: *live migration* of VMs, *memory and file migrations*, and *dynamic deployment* of virtual clusters.

When a traditional VM is initialized, the administrator needs to manually write configuration information or specify the configuration sources. When more VMs join a network, an inefficient configuration always causes problems with overloading or underutilization. Amazon's *Elastic Compute Cloud (EC2)* is a good example of a web service that provides elastic computing power in a cloud. EC2 permits customers to create VMs and to manage user accounts over the time of their use. Most virtualization platforms, including XenServer and VMware ESX Server, support a bridging mode which allows all domains to appear on the network as individual hosts. By using this mode, VMs can communicate with one another freely through the virtual network interface card and configure the network automatically.

3.4.1 Physical versus Virtual Clusters

Virtual clusters are built with VMs installed at distributed servers from one or more physical clusters. The VMs in a virtual cluster are interconnected logically by a virtual network across several physical networks. Figure 3.18 illustrates the concepts of virtual clusters and physical clusters. Each virtual cluster is formed with physical machines or a VM hosted by multiple physical clusters. The virtual cluster boundaries are shown as distinct boundaries.

The provisioning of VMs to a virtual cluster is done dynamically to have the following interesting properties:

- The virtual cluster nodes can be either physical or virtual machines. Multiple VMs running with different OSes can be deployed on the same physical node.
- A VM runs with a guest OS, which is often different from the host OS, that manages the resources in the physical machine, where the VM is implemented.
- The purpose of using VMs is to consolidate multiple functionalities on the same server. This will greatly enhance server utilization and application flexibility.

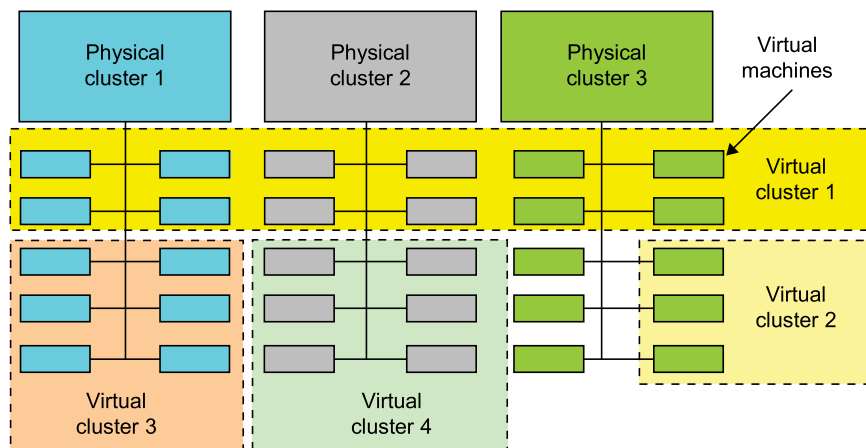

FIGURE 3.18

A cloud platform with four virtual clusters over three physical clusters shaded differently.

(Courtesy of Fan Zhang, Tsinghua University)

- VMs can be colonized (replicated) in multiple servers for the purpose of promoting distributed parallelism, fault tolerance, and disaster recovery.
- The size (number of nodes) of a virtual cluster can grow or shrink dynamically, similar to the way an overlay network varies in size in a peer-to-peer (P2P) network.
- The failure of any physical nodes may disable some VMs installed on the failing nodes. But the failure of VMs will not pull down the host system.

Since system virtualization has been widely used, it is necessary to effectively manage VMs running on a mass of physical computing nodes (also called virtual clusters) and consequently build a high-performance virtualized computing environment. This involves virtual cluster deployment, monitoring and management over large-scale clusters, as well as resource scheduling, load balancing, server consolidation, fault tolerance, and other techniques. The different node colors in Figure 3.18 refer to different virtual clusters. In a virtual cluster system, it is quite important to store the large number of VM images efficiently.

Figure 3.19 shows the concept of a virtual cluster based on application partitioning or customization. The different colors in the figure represent the nodes in different virtual clusters. As a large number of VM images might be present, the most important thing is to determine how to store those images in the system efficiently. There are common installations for most users or applications, such as operating systems or user-level programming libraries. These software packages can be preinstalled as templates (called template VMs). With these templates, users can build their own software stacks. New OS instances can be copied from the template VM. User-specific components such as programming libraries and applications can be installed to those instances.

Three physical clusters are shown on the left side of Figure 3.18. Four virtual clusters are created on the right, over the physical clusters. The physical machines are also called *host systems*. In contrast, the VMs are *guest systems*. The host and guest systems may run with different operating

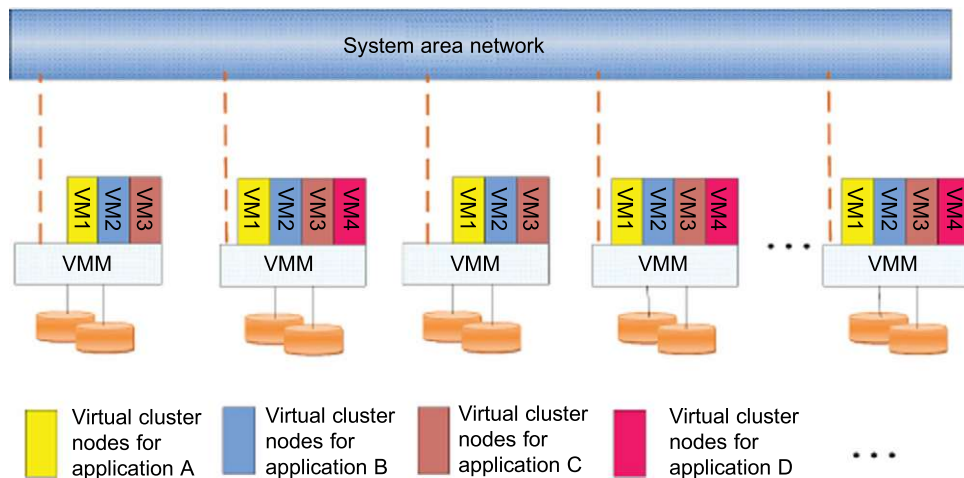

FIGURE 3.19

The concept of a virtual cluster based on application partitioning.

(Courtesy of Kang Chen, Tsinghua University 2008)

systems. Each VM can be installed on a remote server or replicated on multiple servers belonging to the same or different physical clusters. The boundary of a virtual cluster can change as VM nodes are added, removed, or migrated dynamically over time.

3.4.1.1 Fast Deployment and Effective Scheduling

The system should have the capability of fast deployment. Here, deployment means two things: to construct and distribute software stacks (OS, libraries, applications) to a physical node inside clusters as fast as possible, and to quickly switch runtime environments from one user's virtual cluster to another user's virtual cluster. If one user finishes using his system, the corresponding virtual cluster should shut down or suspend quickly to save the resources to run other VMs for other users.

The concept of "green computing" has attracted much attention recently. However, previous approaches have focused on saving the energy cost of components in a single workstation without a global vision. Consequently, they do not necessarily reduce the power consumption of the whole cluster. Other cluster-wide energy-efficient techniques can only be applied to homogeneous workstations and specific applications. The live migration of VMs allows workloads of one node to transfer to another node. However, it does not guarantee that VMs can randomly migrate among themselves. In fact, the potential overhead caused by live migrations of VMs cannot be ignored.

The overhead may have serious negative effects on cluster utilization, throughput, and QoS issues. Therefore, the challenge is to determine how to design migration strategies to implement green computing without influencing the performance of clusters. Another advantage of virtualization is load balancing of applications in a virtual cluster. Load balancing can be achieved using the load index and frequency of user logins. The automatic scale-up and scale-down mechanism of a virtual cluster can be implemented based on this model. Consequently, we can increase the resource utilization of nodes and shorten the response time of systems. Mapping VMs onto the most appropriate physical node should promote performance. Dynamically adjusting loads among nodes by live migration of VMs is desired, when the loads on cluster nodes become quite unbalanced.

3.4.1.2 High-Performance Virtual Storage

The template VM can be distributed to several physical hosts in the cluster to customize the VMs. In addition, existing software packages reduce the time for customization as well as switching virtual environments. It is important to efficiently manage the disk spaces occupied by template software packages. Some storage architecture design can be applied to reduce duplicated blocks in a distributed file system of virtual clusters. Hash values are used to compare the contents of data blocks. Users have their own profiles which store the identification of the data blocks for corresponding VMs in a user-specific virtual cluster. New blocks are created when users modify the corresponding data. Newly created blocks are identified in the users' profiles.

Basically, there are four steps to deploy a group of VMs onto a target cluster: *preparing the disk image*, *configuring the VMs*, *choosing the destination nodes*, and *executing the VM deployment command* on every host. Many systems use templates to simplify the disk image preparation process. A template is a disk image that includes a preinstalled operating system with or without certain application software. Users choose a proper template according to their requirements and make a duplicate of it as their own disk image. Templates could implement the *COW (Copy on Write)* format. A new COW backup file is very small and easy to create and transfer. Therefore, it definitely reduces disk space consumption. In addition, VM deployment time is much shorter than that of copying the whole raw image file.

Every VM is configured with a name, disk image, network setting, and allocated CPU and memory. One needs to record each VM configuration into a file. However, this method is inefficient when managing a large group of VMs. VMs with the same configurations could use preedited profiles to simplify the process. In this scenario, the system configures the VMs according to the chosen profile. Most configuration items use the same settings, while some of them, such as UUID, VM name, and IP address, are assigned with automatically calculated values. Normally, users do not care which host is running their VM. A strategy to choose the proper destination host for any VM is needed. The deployment principle is to fulfill the VM requirement and to balance workloads among the whole host network.

3.4.2 Live VM Migration Steps and Performance Effects

In a cluster built with mixed nodes of host and guest systems, the normal method of operation is to run everything on the physical machine. When a VM fails, its role could be replaced by another VM on a different node, as long as they both run with the same guest OS. In other words, a physical node can fail over to a VM on another host. This is different from physical-to-physical failover in a traditional physical cluster. The advantage is enhanced failover flexibility. The potential drawback is that a VM must stop playing its role if its residing host node fails. However, this problem can be mitigated with VM life migration. Figure 3.20 shows the process of life migration of a VM from host A to host B. The migration copies the VM state file from the storage area to the host machine.

There are four ways to manage a virtual cluster. First, you can use a *guest-based manager*, by which the cluster manager resides on a guest system. In this case, multiple VMs form a virtual cluster. For example, openMosix is an open source Linux cluster running different guest systems on top of the Xen hypervisor. Another example is Sun's cluster Oasis, an experimental Solaris cluster of VMs supported by a VMware VMM. Second, you can build a cluster manager on the host systems. The *host-based manager* supervises the guest systems and can restart the guest system on another physical machine. A good example is the VMware HA system that can restart a guest system after failure.

These two cluster management systems are either guest-only or host-only, but they do not mix. A third way to manage a virtual cluster is to use an *independent cluster manager* on both the host and guest systems. This will make infrastructure management more complex, however. Finally, you can use an *integrated cluster* on the guest and host systems. This means the manager must be designed to distinguish between virtualized resources and physical resources. Various cluster management schemes can be greatly enhanced when VM life migration is enabled with minimal overhead.

VMs can be live-migrated from one physical machine to another; in case of failure, one VM can be replaced by another VM. Virtual clusters can be applied in computational grids, cloud platforms, and high-performance computing (HPC) systems. The major attraction of this scenario is that virtual clustering provides dynamic resources that can be quickly put together upon user demand or after a node failure. In particular, virtual clustering plays a key role in cloud computing. When a VM runs a live service, it is necessary to make a trade-off to ensure that the migration occurs in a manner that minimizes all three metrics. The motivation is to design a live VM migration scheme with negligible downtime, the lowest network bandwidth consumption possible, and a reasonable total migration time.

Furthermore, we should ensure that the migration will not disrupt other active services residing in the same host through resource contention (e.g., CPU, network bandwidth). A VM can be in one of the following four states. An *inactive state* is defined by the virtualization platform, under which

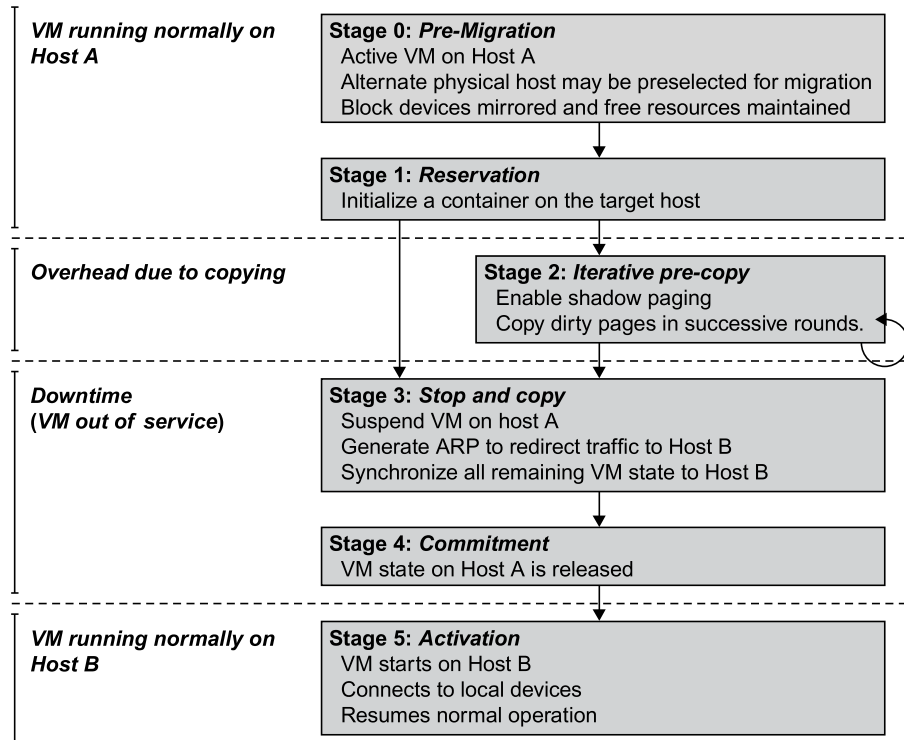

FIGURE 3.20

Live migration process of a VM from one host to another.

(Courtesy of C. Clark, et al. [14])

the VM is not enabled. An *active state* refers to a VM that has been instantiated at the virtualization platform to perform a real task. A *paused state* corresponds to a VM that has been instantiated but disabled to process a task or paused in a waiting state. A VM enters the *suspended state* if its machine file and virtual resources are stored back to the disk. As shown in Figure 3.20, live migration of a VM consists of the following six steps:

Steps 0 and 1: Start migration. This step makes preparations for the migration, including determining the migrating VM and the destination host. Although users could manually make a VM migrate to an appointed host, in most circumstances, the migration is automatically started by strategies such as load balancing and server consolidation.

Steps 2: Transfer memory. Since the whole execution state of the VM is stored in memory, sending the VM's memory to the destination node ensures continuity of the service provided by the VM. All of the memory data is transferred in the first round, and then the migration controller recopies the memory data which is changed in the last round. These steps keep iterating until the dirty portion of the memory is small enough to handle the final copy. Although precopying memory is performed iteratively, the execution of programs is not obviously interrupted.

Step 3: Suspend the VM and copy the last portion of the data. The migrating VM's execution is suspended when the last round's memory data is transferred. Other nonmemory data such as CPU and network states should be sent as well. During this step, the VM is stopped and its applications will no longer run. This "service unavailable" time is called the "downtime" of migration, which should be as short as possible so that it can be negligible to users.

Steps 4 and 5: Commit and activate the new host. After all the needed data is copied, on the destination host, the VM reloads the states and recovers the execution of programs in it, and the service provided by this VM continues. Then the network connection is redirected to the new VM and the dependency to the source host is cleared. The whole migration process finishes by removing the original VM from the source host.

Figure 3.21 shows the effect on the data transmission rate (Mbit/second) of live migration of a VM from one host to another. Before copying the VM with 512 KB files for 100 clients, the data throughput was 870 MB/second. The first precopy takes 63 seconds, during which the rate is reduced to 765 MB/second. Then the data rate reduces to 694 MB/second in 9.8 seconds for more iterations of the copying process. The system experiences only 165 ms of downtime, before the VM is restored at the destination host. This experimental result shows a very small migration overhead in live transfer of a VM between host nodes. This is critical to achieve dynamic cluster reconfiguration and disaster recovery as needed in cloud computing. We will study these techniques in more detail in Chapter 4.

With the emergence of widespread cluster computing more than a decade ago, many cluster configuration and management systems have been developed to achieve a range of goals. These goals naturally influence individual approaches to cluster management. VM technology has become a popular method for simplifying management and sharing of physical computing resources. Platforms

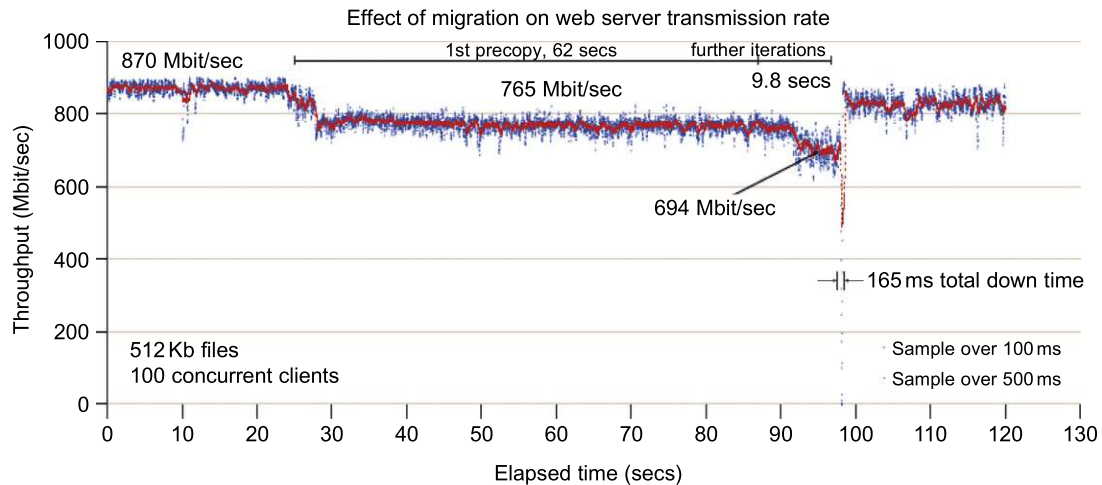

FIGURE 3.21

Effect on data transmission rate of a VM migrated from one failing web server to another.

(Courtesy of C. Clark, et al. [14])

such as VMware and Xen allow multiple VMs with different operating systems and configurations to coexist on the same physical host in mutual isolation. Clustering inexpensive computers is an effective way to obtain reliable, scalable computing power for network services and compute-intensive applications

3.4.3 Migration of Memory, Files, and Network Resources

Since clusters have a high initial cost of ownership, including space, power conditioning, and cooling equipment, leasing or sharing access to a common cluster is an attractive solution when demands vary over time. Shared clusters offer economies of scale and more effective utilization of resources by multiplexing. Early configuration and management systems focus on expressive and scalable mechanisms for defining clusters for specific types of service, and physically partition cluster nodes among those types. When one system migrates to another physical node, we should consider the following issues.

3.4.3.1 Memory Migration

This is one of the most important aspects of VM migration. Moving the memory instance of a VM from one physical host to another can be approached in any number of ways. But traditionally, the concepts behind the techniques tend to share common implementation paradigms. The techniques employed for this purpose depend upon the characteristics of application/workloads supported by the guest OS.

Memory migration can be in a range of hundreds of megabytes to a few gigabytes in a typical system today, and it needs to be done in an efficient manner. The *Internet Suspend-Resume (ISR)* technique exploits temporal locality as memory states are likely to have considerable overlap in the suspended and the resumed instances of a VM. Temporal locality refers to the fact that the memory states differ only by the amount of work done since a VM was last suspended before being initiated for migration.

To exploit temporal locality, each file in the file system is represented as a tree of small subfiles. A copy of this tree exists in both the suspended and resumed VM instances. The advantage of using a tree-based representation of files is that the caching ensures the transmission of only those files which have been changed. The ISR technique deals with situations where the migration of live machines is not a necessity. Predictably, the downtime (the period during which the service is unavailable due to there being no currently executing instance of a VM) is high, compared to some of the other techniques discussed later.

3.4.3.2 File System Migration

To support VM migration, a system must provide each VM with a consistent, location-independent view of the file system that is available on all hosts. A simple way to achieve this is to provide each VM with its own virtual disk which the file system is mapped to and transport the contents of this virtual disk along with the other states of the VM. However, due to the current trend of high-capacity disks, migration of the contents of an entire disk over a network is not a viable solution. Another way is to have a global file system across all machines where a VM could be located. This way removes the need to copy files from one machine to another because all files are network-accessible.

A distributed file system is used in ISR serving as a transport mechanism for propagating a suspended VM state. The actual file systems themselves are not mapped onto the distributed file system. Instead, the VMM only accesses its local file system. The relevant VM files are explicitly copied into the local file system for a resume operation and taken out of the local file system for a suspend operation. This approach relieves developers from the complexities of implementing several different file system calls for different distributed file systems. It also essentially disassociates the VMM from any particular distributed file system semantics. However, this decoupling means that the VMM has to store the contents of each VM's virtual disks in its local files, which have to be moved around with the other state information of that VM.

In smart copying, the VMM exploits spatial locality. Typically, people often move between the same small number of locations, such as their home and office. In these conditions, it is possible to transmit only the difference between the two file systems at suspending and resuming locations. This technique significantly reduces the amount of actual physical data that has to be moved. In situations where there is no locality to exploit, a different approach is to synthesize much of the state at the resuming site. On many systems, user files only form a small fraction of the actual data on disk. Operating system and application software account for the majority of storage space. The proactive state transfer solution works in those cases where the resuming site can be predicted with reasonable confidence.

3.4.3.3 Network Migration

A migrating VM should maintain all open network connections without relying on forwarding mechanisms on the original host or on support from mobility or redirection mechanisms. To enable remote systems to locate and communicate with a VM, each VM must be assigned a virtual IP address known to other entities. This address can be distinct from the IP address of the host machine where the VM is currently located. Each VM can also have its own distinct virtual MAC address. The VMM maintains a mapping of the virtual IP and MAC addresses to their corresponding VMs. In general, a migrating VM includes all the protocol states and carries its IP address with it.

If the source and destination machines of a VM migration are typically connected to a single switched LAN, an unsolicited ARP reply from the migrating host is provided advertising that the IP has moved to a new location. This solves the open network connection problem by reconfiguring all the peers to send future packets to a new location. Although a few packets that have already been transmitted might be lost, there are no other problems with this mechanism. Alternatively, on a switched network, the migrating OS can keep its original Ethernet MAC address and rely on the network switch to detect its move to a new port.

Live migration means moving a VM from one physical node to another while keeping its OS environment and applications unbroken. This capability is being increasingly utilized in today's enterprise environments to provide efficient online system maintenance, reconfiguration, load balancing, and proactive fault tolerance. It provides desirable features to satisfy requirements for computing resources in modern computing systems, including server consolidation, performance isolation, and ease of management. As a result, many implementations are available which support the feature using disparate functionalities. Traditional migration suspends VMs before the transportation and then resumes them at the end of the process. By importing the precopy mechanism, a VM could be live-migrated without stopping the VM and keep the applications running during the migration.

Live migration is a key feature of system virtualization technologies. Here, we focus on VM migration within a cluster environment where a network-accessible storage system, such as *storage*

area network (SAN) or *network attached storage* (NAS), is employed. Only memory and CPU status needs to be transferred from the source node to the target node. Live migration techniques mainly use the precopy approach, which first transfers all memory pages, and then only copies modified pages during the last round iteratively. The VM service downtime is expected to be minimal by using iterative copy operations. When applications' writable working set becomes small, the VM is suspended and only the CPU state and dirty pages in the last round are sent out to the destination.

In the precopy phase, although a VM service is still available, much performance degradation will occur because the migration daemon continually consumes network bandwidth to transfer dirty pages in each round. An adaptive rate limiting approach is employed to mitigate this issue, but total migration time is prolonged by nearly 10 times. Moreover, the maximum number of iterations must be set because not all applications' dirty pages are ensured to converge to a small writable working set over multiple rounds.

In fact, these issues with the precopy approach are caused by the large amount of transferred data during the whole migration process. A checkpointing/recovery and trace/replay approach (CR/TR-Motion) is proposed to provide fast VM migration. This approach transfers the execution trace file in iterations rather than dirty pages, which is logged by a trace daemon. Apparently, the total size of all log files is much less than that of dirty pages. So, total migration time and downtime of migration are drastically reduced. However, CR/TR-Motion is valid only when the log replay rate is larger than the log growth rate. The inequality between source and target nodes limits the application scope of live migration in clusters.

Another strategy of postcopy is introduced for live migration of VMs. Here, all memory pages are transferred only once during the whole migration process and the baseline total migration time is reduced. But the downtime is much higher than that of precopy due to the latency of fetching pages from the source node before the VM can be resumed on the target. With the advent of multicore or many-core machines, abundant CPU resources are available. Even if several VMs reside on a same multicore machine, CPU resources are still rich because physical CPUs are frequently amenable to multiplexing. We can exploit these copious CPU resources to compress page frames and the amount of transferred data can be significantly reduced. Memory compression algorithms typically have little memory overhead. Decompression is simple and very fast and requires no memory for decompression.

3.4.3.4 Live Migration of VM Using Xen

In Section 3.2.1, we studied Xen as a VMM or hypervisor, which allows multiple commodity OSes to share x86 hardware in a safe and orderly fashion. The following example explains how to perform live migration of a VM between two Xen-enabled host machines. Domain 0 (or Dom0) performs tasks to create, terminate, or migrate to another host. Xen uses a send/rcv model to transfer states across VMs.

Example 3.8 Live Migration of VMs between Two Xen-Enabled Hosts

Xen supports live migration. It is a useful feature and natural extension to virtualization platforms that allows for the transfer of a VM from one physical machine to another with little or no downtime of the services hosted by the VM. Live migration transfers the working state and memory of a VM across a network when it is running. Xen also supports VM migration by using a mechanism called *Remote Direct Memory Access (RDMA)*.

RDMA speeds up VM migration by avoiding TCP/IP stack processing overhead. RDMA implements a different transfer protocol whose origin and destination VM buffers must be registered before any transfer

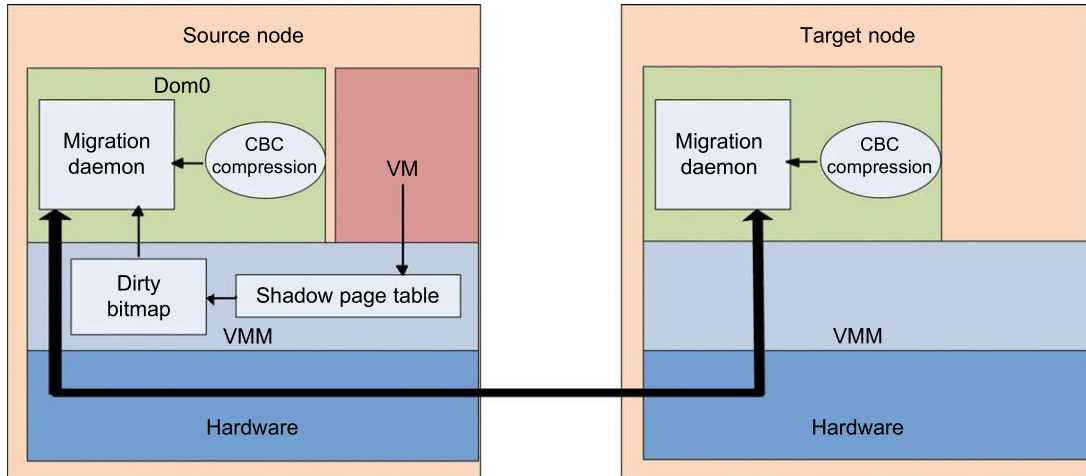
**FIGURE 3.22**

Live migration of VM from the Dom0 domain to a Xen-enabled target host.

operations occur, reducing it to a “one-sided” interface. Data communication over RDMA does not need to involve the CPU, caches, or context switches. This allows migration to be carried out with minimal impact on guest operating systems and hosted applications. Figure 3.22 shows the a compression scheme for VM migration.

This design requires that we make trade-offs between two factors. If an algorithm embodies expectations about the kinds of regularities in the memory footprint, it must be very fast and effective. A single compression algorithm for all memory data is difficult to achieve the win-win status that we expect. Therefore, it is necessary to provide compression algorithms to pages with different kinds of regularities. The structure of this live migration system is presented in Dom0.

Migration daemons running in the management VMs are responsible for performing migration. Shadow page tables in the VMM layer trace modifications to the memory page in migrated VMs during the precopy phase. Corresponding flags are set in a dirty bitmap. At the start of each precopy round, the bitmap is sent to the migration daemon. Then, the bitmap is cleared and the shadow page tables are destroyed and re-created in the next round. The system resides in Xen’s management VM. Memory pages denoted by bitmap are extracted and compressed before they are sent to the destination. The compressed data is then decompressed on the target.

3.4.4 Dynamic Deployment of Virtual Clusters

Table 3.5 summarizes four virtual cluster research projects. We briefly introduce them here just to identify their design objectives and reported results. The Cellular Disco at Stanford is a virtual cluster built in a shared-memory multiprocessor system. The INRIA virtual cluster was built to test parallel algorithm performance. The COD and VIOLIN clusters are studied in forthcoming examples.

Project Name	Design Objectives	Reported Results and References
Cluster-on-Demand at Duke Univ.	Dynamic resource allocation with a virtual cluster management system	Sharing of VMs by multiple virtual clusters using Sun GridEngine [12]
Cellular Disco at Stanford Univ.	To deploy a virtual cluster on a shared-memory multiprocessor	VMs deployed on multiple processors under a VMM called Cellular Disco [8]
VIOLIN at Purdue Univ.	Multiple VM clustering to prove the advantage of dynamic adaptation	Reduce execution time of applications running VIOLIN with adaptation [25,55]
GRAAL Project at INRIA in France	Performance of parallel algorithms in Xen-enabled virtual clusters	75% of max. performance achieved with 30% resource slacks over VM clusters

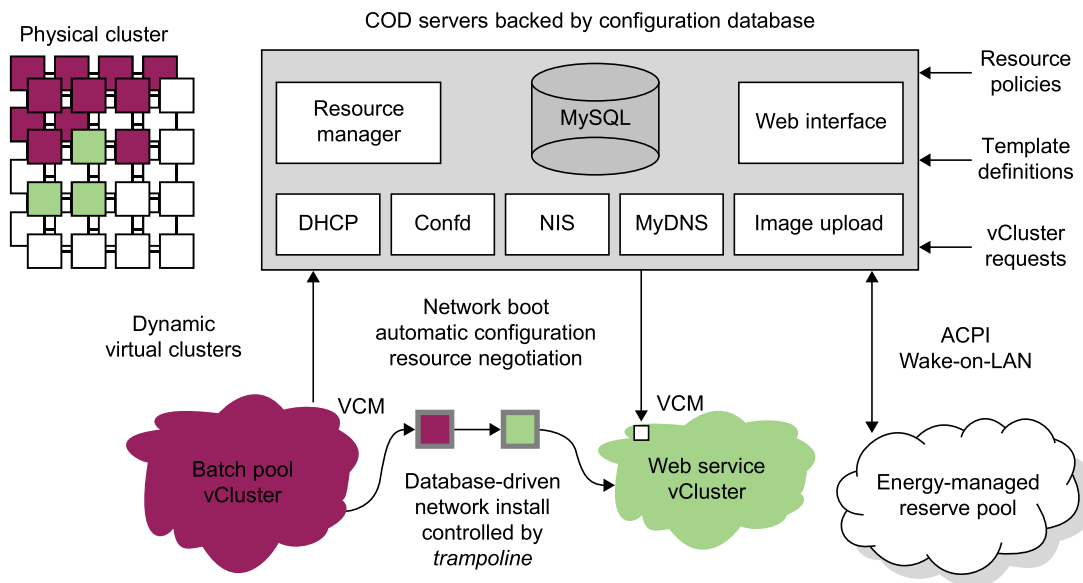

FIGURE 3.23

COD partitioning a physical cluster into multiple virtual clusters.

(Courtesy of Jeff Chase, et al., HPDC-2003 © IEEE [12])

Example 3.9 The Cluster-on-Demand (COD) Project at Duke University

Developed by researchers at Duke University, the COD (*Cluster-on-Demand*) project is a virtual cluster management system for dynamic allocation of servers from a computing pool to multiple virtual clusters [12]. The idea is illustrated by the prototype implementation of the COD shown in Figure 3.23. The COD

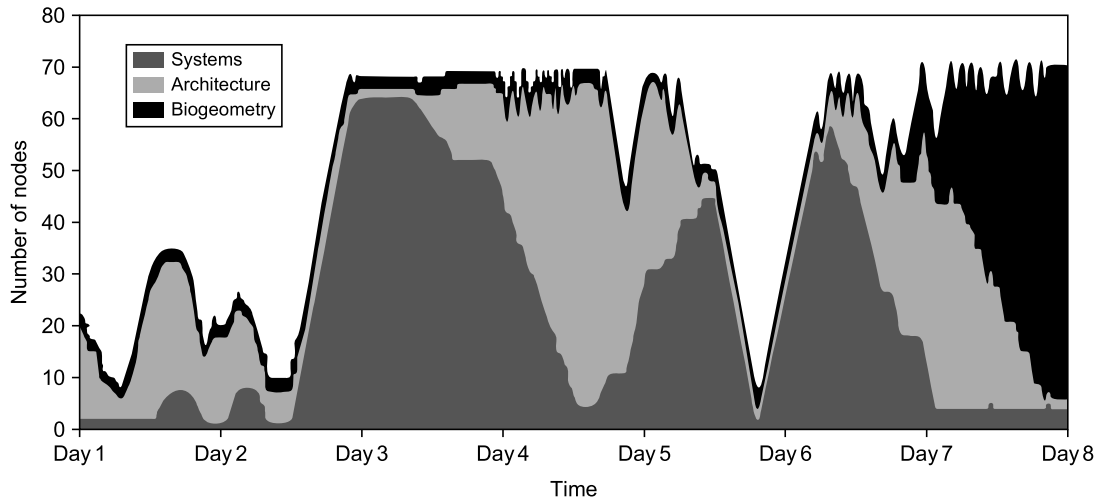
**FIGURE 3.24**

Cluster size variations in COD over eight days at Duke University.

(Courtesy of Jeff Chase, et al., HPDC-2003 © IEEE [12])

partitions a physical cluster into multiple virtual clusters (*vClusters*). *vCluster* owners specify the operating systems and software for their clusters through an XML-RPC interface. The *vClusters* run a batch schedule from Sun's GridEngine on a web server cluster. The COD system can respond to load changes in restructuring the virtual clusters dynamically.

The Duke researchers used the Sun GridEngine scheduler to demonstrate that dynamic virtual clusters are an enabling abstraction for advanced resource management in computing utilities such as grids. The system supports dynamic, policy-based cluster sharing between local users and hosted grid services. Attractive features include resource reservation, adaptive provisioning, scavenging of idle resources, and dynamic instantiation of grid services. The COD servers are backed by a configuration database. This system provides resource policies and template definition in response to user requests.

Figure 3.24 shows the variation in the number of nodes in each of three virtual clusters during eight days of a live deployment. Three application workloads requested by three user groups are labeled "Systems," "Architecture," and "BioGeometry" in the trace plot. The experiments were performed with multiple SGE batch pools on a test bed of 80 rack-mounted IBM xSeries-335 servers within the Duke cluster. This trace plot clearly shows the sharp variation in cluster size (number of nodes) over the eight days. Dynamic provisioning and deprovisioning of virtual clusters are needed in real-life cluster applications.

Example 3.10 The VIOLIN Project at Purdue University

The Purdue VIOLIN Project applies live VM migration to reconfigure a virtual cluster environment. Its purpose is to achieve better resource utilization in executing multiple cluster jobs on multiple cluster

domains. The project leverages the maturity of VM migration and environment adaptation technology. The approach is to enable mutually isolated virtual environments for executing parallel applications on top of a shared physical infrastructure consisting of multiple domains. Figure 3.25 illustrates the idea with five concurrent virtual environments, labeled as VIOLIN 1–5, sharing two physical clusters.

The squares of various shadings represent the VMs deployed in the physical server nodes. The major contribution by the Purdue group is to achieve autonomic adaptation of the virtual computation environments as active, integrated entities. A virtual execution environment is able to relocate itself across the infrastructure, and can scale its share of infrastructural resources. The adaptation is transparent to both users of virtual environments and administrations of infrastructures. The adaptation overhead is maintained at 20 sec out of 1,200 sec in solving a large NEMO3D problem of 1 million particles.

The message being conveyed here is that the virtual environment adaptation can enhance resource utilization significantly at the expense of less than 1 percent of an increase in total execution time. The

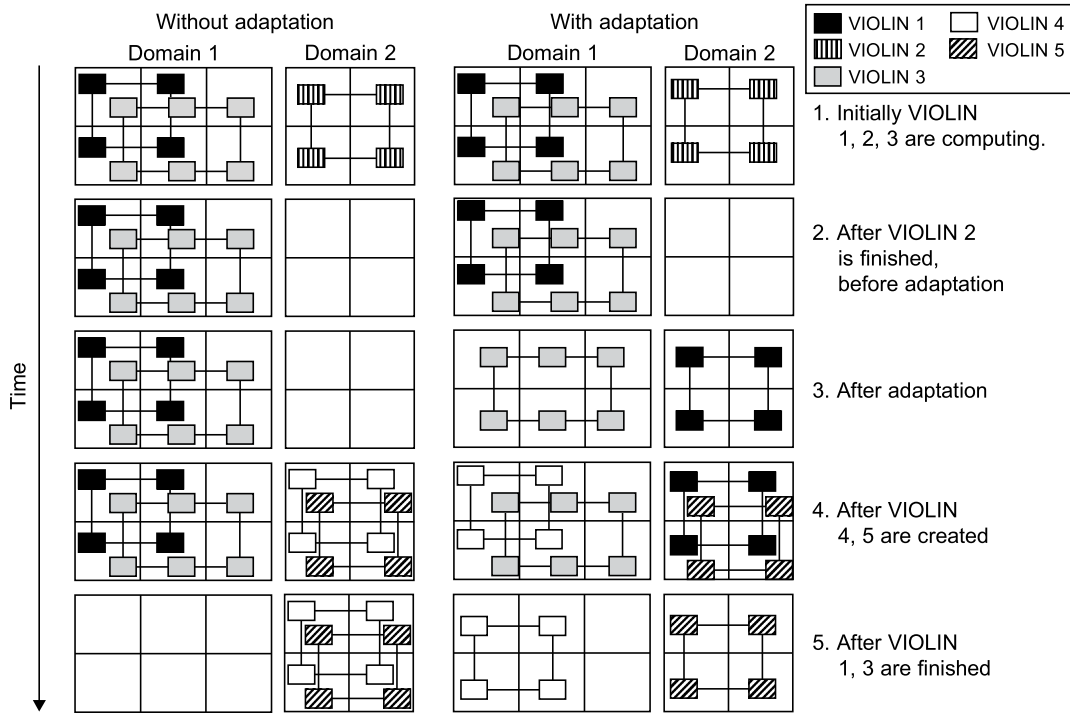

FIGURE 3.25

VIOLIN adaptation scenario of five virtual environments sharing two hosted clusters. Note that there are more idle squares (blank nodes) before and after the adaptation.

(Courtesy of P. Ruth, et al. [55])

migration of VIOLIN environments does pay off. Of course, the gain in shared resource utilization will benefit many users, and the performance gain varies with different adaptation scenarios. We leave readers to trace the execution of another scenario in [Problem 3.17](#) at the end of this chapter to tell the differences. Virtual networking is a fundamental component of the VIOLIN system.

3.5 VIRTUALIZATION FOR DATA-CENTER AUTOMATION

Data centers have grown rapidly in recent years, and all major IT companies are pouring their resources into building new data centers. In addition, Google, Yahoo!, Amazon, Microsoft, HP, Apple, and IBM are all in the game. All these companies have invested billions of dollars in data-center construction and automation. Data-center automation means that huge volumes of hardware, software, and database resources in these data centers can be allocated dynamically to millions of Internet users simultaneously, with guaranteed QoS and cost-effectiveness.

This automation process is triggered by the growth of virtualization products and cloud computing services. From 2006 to 2011, according to an IDC 2007 report on the growth of virtualization and its market distribution in major IT sectors. In 2006, virtualization has a market share of \$1,044 million in business and enterprise opportunities. The majority was dominated by production consolidation and software development. Virtualization is moving towards enhancing mobility, reducing planned downtime (for maintenance), and increasing the number of virtual clients.

The latest virtualization development highlights *high availability* (HA), backup services, workload balancing, and further increases in client bases. IDC projected that automation, service orientation, policy-based, and variable costs in the virtualization market. The total business opportunities may increase to \$3.2 billion by 2011. The major market share moves to the areas of HA, utility computing, production consolidation, and client bases. In what follows, we will discuss server consolidation, virtual storage, OS support, and trust management in automated data-center designs.

3.5.1 Server Consolidation in Data Centers

In data centers, a large number of heterogeneous workloads can run on servers at various times. These heterogeneous workloads can be roughly divided into two categories: chatty workloads and noninteractive workloads. Chatty workloads may burst at some point and return to a silent state at some other point. A web video service is an example of this, whereby a lot of people use it at night and few people use it during the day. Noninteractive workloads do not require people's efforts to make progress after they are submitted. High-performance computing is a typical example of this. At various stages, the requirements for resources of these workloads are dramatically different. However, to guarantee that a workload will always be able to cope with all demand levels, the workload is statically allocated enough resources so that peak demand is satisfied. [Figure 3.29](#) illustrates server virtualization in a data center. In this case, the granularity of resource optimization is focused on the CPU, memory, and network interfaces.

Therefore, it is common that most servers in data centers are underutilized. A large amount of hardware, space, power, and management cost of these servers is wasted. Server consolidation is an approach to improve the low utility ratio of hardware resources by reducing the number of physical servers. Among several server consolidation techniques such as centralized and physical consolidation, virtualization-based server consolidation is the most powerful. Data centers need to optimize their resource management. Yet these techniques are performed with the granularity of a full server machine, which makes resource management far from well optimized. Server virtualization enables smaller resource allocation than a physical machine.

In general, the use of VMs increases resource management complexity. This causes a challenge in terms of how to improve resource utilization as well as guarantee QoS in data centers. In detail, server virtualization has the following side effects:

- Consolidation enhances hardware utilization. Many underutilized servers are consolidated into fewer servers to enhance resource utilization. Consolidation also facilitates backup services and disaster recovery.
- This approach enables more agile provisioning and deployment of resources. In a virtual environment, the images of the guest OSes and their applications are readily cloned and reused.
- The total cost of ownership is reduced. In this sense, server virtualization causes deferred purchases of new servers, a smaller data-center footprint, lower maintenance costs, and lower power, cooling, and cabling requirements.
- This approach improves availability and business continuity. The crash of a guest OS has no effect on the host OS or any other guest OS. It becomes easier to transfer a VM from one server to another, because virtual servers are unaware of the underlying hardware.

To automate data-center operations, one must consider resource scheduling, architectural support, power management, automatic or autonomic resource management, performance of analytical models, and so on. In virtualized data centers, an efficient, on-demand, fine-grained scheduler is one of the key factors to improve resource utilization. Scheduling and reallocations can be done in a wide range of levels in a set of data centers. The levels match at least at the VM level, server level, and data-center level. Ideally, scheduling and resource reallocations should be done at all levels. However, due to the complexity of this, current techniques only focus on a single level or, at most, two levels.

Dynamic CPU allocation is based on VM utilization and application-level QoS metrics. One method considers both CPU and memory flowing as well as automatically adjusting resource overhead based on varying workloads in hosted services. Another scheme uses a two-level resource management system to handle the complexity involved. A local controller at the VM level and a global controller at the server level are designed. They implement autonomic resource allocation via the interaction of the local and global controllers. Multicore and virtualization are two cutting techniques that can enhance each other.

However, the use of CMP is far from well optimized. The memory system of CMP is a typical example. One can design a virtual hierarchy on a CMP in data centers. One can consider protocols that minimize the memory access time, inter-VM interferences, facilitating VM reassignment, and supporting inter-VM sharing. One can also consider a VM-aware power budgeting scheme using multiple managers integrated to achieve better power management. The power budgeting policies cannot ignore the heterogeneity problems. Consequently, one must address the trade-off of power saving and data-center performance.

3.5.2 Virtual Storage Management

The term “storage virtualization” was widely used before the renaissance of system virtualization. Yet the term has a different meaning in a system virtualization environment. Previously, storage virtualization was largely used to describe the aggregation and repartitioning of disks at very coarse time scales for use by physical machines. In system virtualization, virtual storage includes the storage managed by VMMs and guest OSes. Generally, the data stored in this environment can be classified into two categories: VM images and application data. The VM images are special to the virtual environment, while application data includes all other data which is the same as the data in traditional OS environments.

The most important aspects of system virtualization are encapsulation and isolation. Traditional operating systems and applications running on them can be encapsulated in VMs. Only one operating system runs in a virtualization while many applications run in the operating system. System virtualization allows multiple VMs to run on a physical machine and the VMs are completely isolated. To achieve encapsulation and isolation, both the system software and the hardware platform, such as CPUs and chipsets, are rapidly updated. However, storage is lagging. The storage systems become the main bottleneck of VM deployment.

In virtualization environments, a virtualization layer is inserted between the hardware and traditional operating systems or a traditional operating system is modified to support virtualization. This procedure complicates storage operations. On the one hand, storage management of the guest OS performs as though it is operating in a real hard disk while the guest OSes cannot access the hard disk directly. On the other hand, many guest OSes contest the hard disk when many VMs are running on a single physical machine. Therefore, storage management of the underlying VMM is much more complex than that of guest OSes (traditional OSes).

In addition, the storage primitives used by VMs are not nimble. Hence, operations such as remapping volumes across hosts and checkpointing disks are frequently clumsy and esoteric, and sometimes simply unavailable. In data centers, there are often thousands of VMs, which cause the VM images to become flooded. Many researchers tried to solve these problems in virtual storage management. The main purposes of their research are to make management easy while enhancing performance and reducing the amount of storage occupied by the VM images. Parallax is a distributed storage system customized for virtualization environments. Content Addressable Storage (CAS) is a solution to reduce the total size of VM images, and therefore supports a large set of VM-based systems in data centers.

Since traditional storage management techniques do not consider the features of storage in virtualization environments, Parallax designs a novel architecture in which storage features that have traditionally been implemented directly on high-end storage arrays and switchers are relocated into a federation of storage VMs. These storage VMs share the same physical hosts as the VMs that they serve. [Figure 3.30](#) provides an overview of the Parallax system architecture. It supports all popular system virtualization techniques, such as paravirtualization and full virtualization. For each physical machine, Parallax customizes a special storage appliance VM. The storage appliance VM acts as a block virtualization layer between individual VMs and the physical storage device. It provides a virtual disk for each VM on the same physical machine.

Example 3.11 Parallax Providing Virtual Disks to Client VMs from a Large Common Shared Physical Disk

The architecture of Parallax is scalable and especially suitable for use in cluster-based environments. [Figure 3.26](#) shows a high-level view of the structure of a Parallax-based cluster. A cluster-wide administrative domain manages all storage appliance VMs, which makes storage management easy. The storage appliance

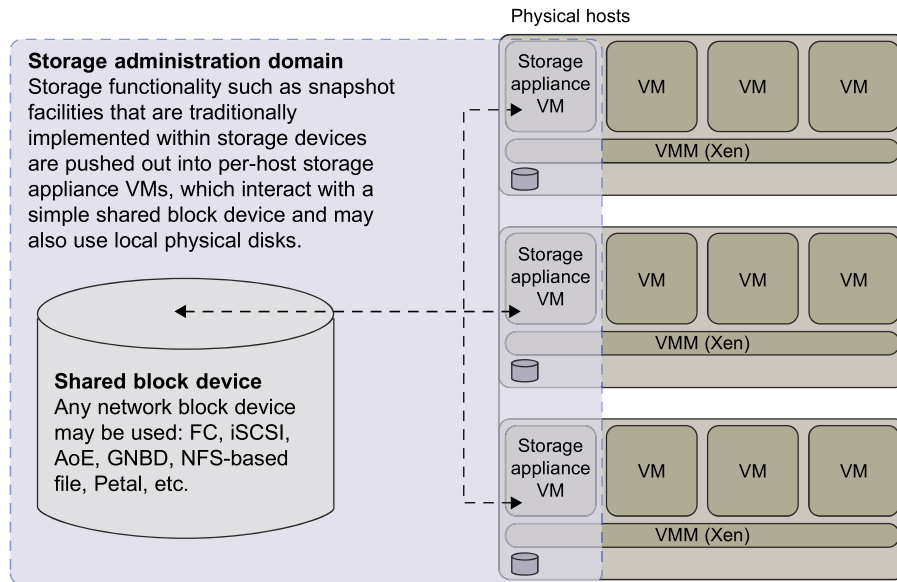

FIGURE 3.26

Parallax is a set of per-host storage appliances that share access to a common block device and presents virtual disks to client VMs.

(Courtesy of D. Meyer, et al. [43])

VM also allows functionality that is currently implemented within data-center hardware to be pushed out and implemented on individual hosts. This mechanism enables advanced storage features such as snapshot facilities to be implemented in software and delivered above commodity network storage targets.

Parallax itself runs as a user-level application in the storage appliance VM. It provides *virtual disk images (VDIs)* to VMs. A VDI is a single-writer virtual disk which may be accessed in a location-transparent manner from any of the physical hosts in the Parallax cluster. The VDIs are the core abstraction provided by Parallax. Parallax uses Xen's block tap driver to handle block requests and it is implemented as a tapdisk library. This library acts as a single block virtualization service for all client VMs on the same physical host. In the Parallax system, it is the storage appliance VM that connects the physical hardware device for block and network access. As shown in Figure 3.30, physical device drivers are included in the storage appliance VM. This implementation enables a storage administrator to live-upgrade the block device drivers in an active cluster.

3.5.3 Cloud OS for Virtualized Data Centers

Data centers must be virtualized to serve as cloud providers. Table 3.6 summarizes four *virtual infrastructure (VI)* managers and OSes. These VI managers and OSes are specially tailored for virtualizing data centers which often own a large number of servers in clusters. Nimbus, Eucalyptus,

Table 3.6 VI Managers and Operating Systems for Virtualizing Data Centers [9]

Manager/ OS, Platforms, License	Resources Being Virtualized, Web Link	Client API, Language	Hypervisors Used	Public Cloud Interface	Special Features
Nimbus Linux, Apache v2	VM creation, virtual cluster, www.nimbusproject.org/	EC2 WS, WSRF, CLI	Xen, KVM	EC2	Virtual networks
Eucalyptus Linux, BSD	Virtual networking (Example 3.12 and [41]), www.eucalyptus.com/	EC2 WS, CLI	Xen, KVM	EC2	Virtual networks
OpenNebula Linux, Apache v2	Management of VM, host, virtual network, and scheduling tools, www.opennebula.org/	XML-RPC, CLI, Java	Xen, KVM	EC2, Elastic Host	Virtual networks, dynamic provisioning
vSphere 4 Linux, Windows, proprietary	Virtualizing OS for data centers (Example 3.13), www.vmware.com/products/vsphere/ [66]	CLI, GUI, Portal, WS	VMware ESX, ESXi	VMware vCloud partners	Data protection, vStorage, VMFS, DRM, HA

and OpenNebula are all open source software available to the general public. Only vSphere 4 is a proprietary OS for cloud resource virtualization and management over data centers.

These VI managers are used to create VMs and aggregate them into virtual clusters as elastic resources. Nimbus and Eucalyptus support essentially virtual networks. OpenNebula has additional features to provision dynamic resources and make advance reservations. All three public VI managers apply Xen and KVM for virtualization. vSphere 4 uses the hypervisors ESX and ESXi from VMware. Only vSphere 4 supports virtual storage in addition to virtual networking and data protection. We will study Eucalyptus and vSphere 4 in the next two examples.

Example 3.12 Eucalyptus for Virtual Networking of Private Cloud

Eucalyptus is an open source software system (Figure 3.27) intended mainly for supporting Infrastructure as a Service (IaaS) clouds. The system primarily supports virtual networking and the management of VMs; virtual storage is not supported. Its purpose is to build private clouds that can interact with end users through Ethernet or the Internet. The system also supports interaction with other private clouds or public clouds over the Internet. The system is short on security and other desired features for general-purpose grid or cloud applications.

The designers of Eucalyptus [45] implemented each high-level system component as a stand-alone web service. Each web service exposes a well-defined language-agnostic API in the form of a WSDL document containing both operations that the service can perform and input/output data structures.

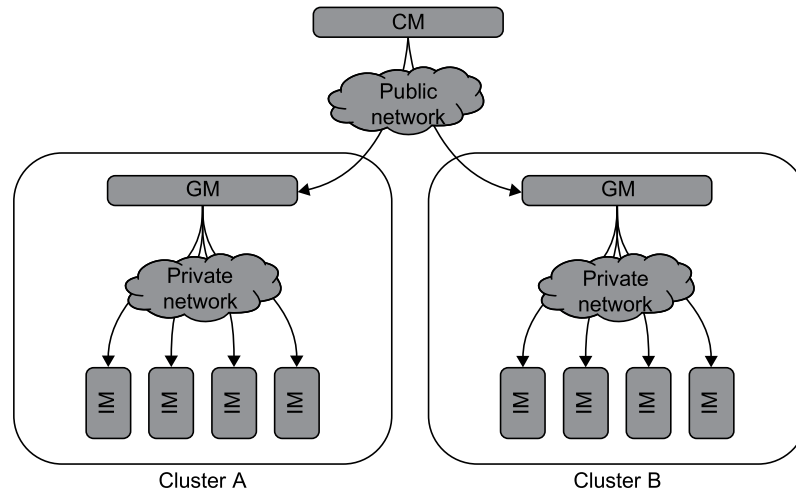
**FIGURE 3.27**

Eucalyptus for building private clouds by establishing virtual networks over the VMs linking through Ethernet and the Internet.

(Courtesy of D. Nurmi, et al. [45])

Furthermore, the designers leverage existing web-service features such as WS-Security policies for secure communication between components. The three resource managers in Figure 3.27 are specified below:

- **Instance Manager** controls the execution, inspection, and terminating of VM instances on the host where it runs.
- **Group Manager** gathers information about and schedules VM execution on specific instance managers, as well as manages virtual instance network.
- **Cloud Manager** is the entry-point into the cloud for users and administrators. It queries node managers for information about resources, makes scheduling decisions, and implements them by making requests to group managers.

In terms of functionality, Eucalyptus works like AWS APIs. Therefore, it can interact with EC2. It does provide a storage API to emulate the Amazon S3 API for storing user data and VM images. It is installed on Linux-based platforms, is compatible with EC2 with SOAP and Query, and is S3-compatible with SOAP and REST. CLI and web portal services can be applied with Eucalyptus.

Example 3.13 VMware vSphere 4 as a Commercial Cloud OS [66]

The vSphere 4 offers a hardware and software ecosystem developed by VMware and released in April 2009. vSphere extends earlier virtualization software products by VMware, namely the VMware Workstation, ESX for server virtualization, and Virtual Infrastructure for server clusters. Figure 3.28 shows vSphere's

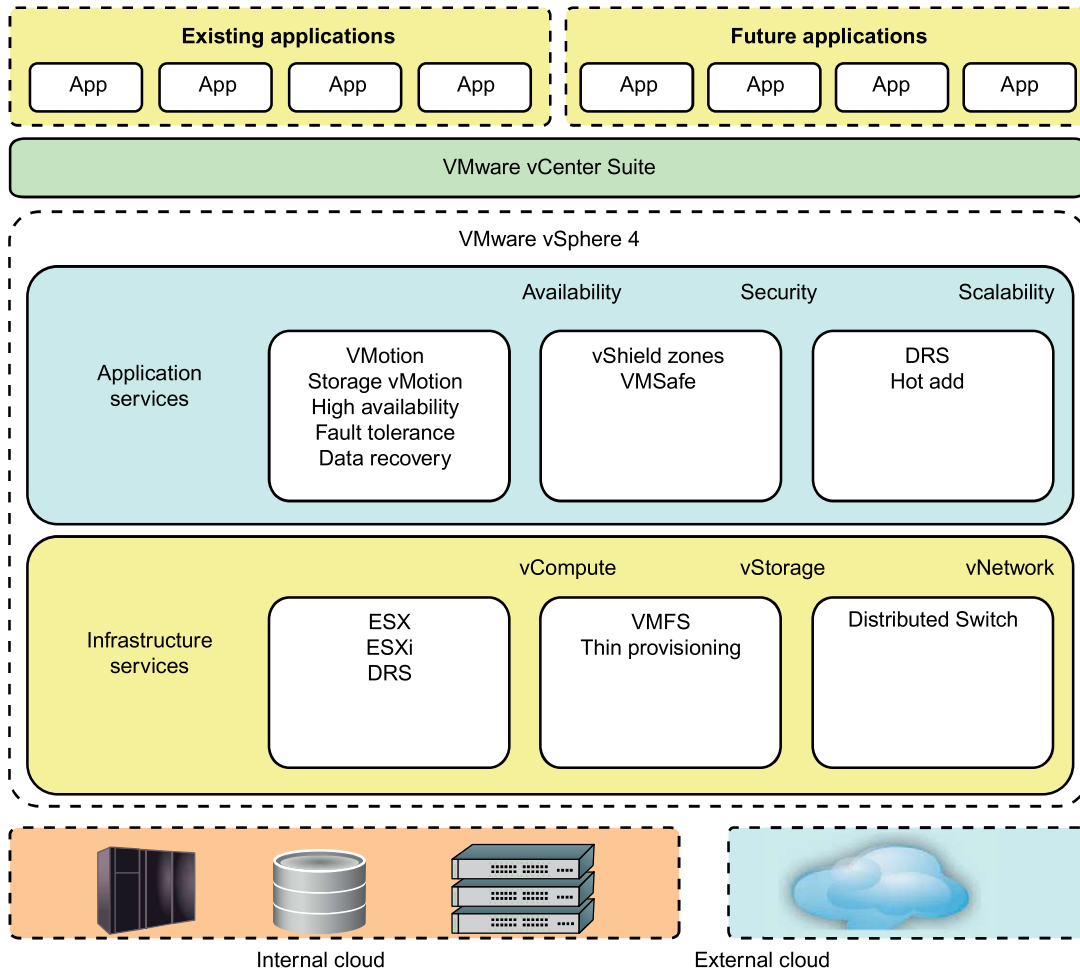
**FIGURE 3.28**

vSphere/4, a cloud operating system that manages compute, storage, and network resources over virtualized data centers.

(Courtesy of VMware, April 2010 [72])

overall architecture. The system interacts with user applications via an interface layer, called *vCenter*. vSphere is primarily intended to offer virtualization support and resource management of data-center resources in building private clouds. VMware claims the system is the first cloud OS that supports availability, security, and scalability in providing cloud computing services.

The vSphere 4 is built with two functional software suites: *infrastructure services* and *application services*. It also has three component packages intended mainly for virtualization purposes: *vCompute* is supported by ESX, ESXi, and DRS virtualization libraries from VMware; *vStorage* is supported by VMS and

thin provisioning libraries; and *vNetwork* offers distributed switching and networking functions. These packages interact with the hardware servers, disks, and networks in the data center. These infrastructure functions also communicate with other external clouds.

The application services are also divided into three groups: *availability*, *security*, and *scalability*. Availability support includes VMotion, Storage VMotion, HA, Fault Tolerance, and Data Recovery from VMware. The security package supports vShield Zones and VMsafe. The scalability package was built with DRS and Hot Add. Interested readers should refer to the vSphere 4 web site for more details regarding these component software functions. To fully understand the use of vSphere 4, users must also learn how to use the vCenter interfaces in order to link with existing applications or to develop new applications. ■

3.5.4 Trust Management in Virtualized Data Centers

A VMM changes the computer architecture. It provides a layer of software between the operating systems and system hardware to create one or more VMs on a single physical platform. A VM entirely encapsulates the state of the guest operating system running inside it. Encapsulated machine state can be copied and shared over the network and removed like a normal file, which proposes a challenge to VM security. In general, a VMM can provide secure isolation and a VM accesses hardware resources through the control of the VMM, so the VMM is the base of the security of a virtual system. Normally, one VM is taken as a management VM to have some privileges such as creating, suspending, resuming, or deleting a VM.

Once a hacker successfully enters the VMM or management VM, the whole system is in danger. A subtler problem arises in protocols that rely on the “freshness” of their random number source for generating session keys. Considering a VM, rolling back to a point after a random number has been chosen, but before it has been used, resumes execution; the random number, which must be “fresh” for security purposes, is reused. With a stream cipher, two different plaintexts could be encrypted under the same key stream, which could, in turn, expose both plaintexts if the plaintexts have sufficient redundancy. Noncryptographic protocols that rely on freshness are also at risk. For example, the reuse of TCP initial sequence numbers can raise TCP hijacking attacks.

3.5.4.1 VM-Based Intrusion Detection

Intrusions are unauthorized access to a certain computer from local or network users and intrusion detection is used to recognize the unauthorized access. An intrusion detection system (IDS) is built on operating systems, and is based on the characteristics of intrusion actions. A typical IDS can be classified as a *host-based IDS (HIDS)* or a *network-based IDS (NIDS)*, depending on the data source. A HIDS can be implemented on the monitored system. When the monitored system is attacked by hackers, the HIDS also faces the risk of being attacked. A NIDS is based on the flow of network traffic which can't detect fake actions.

Virtualization-based intrusion detection can isolate guest VMs on the same hardware platform. Even some VMs can be invaded successfully; they never influence other VMs, which is similar to the way in which a NIDS operates. Furthermore, a VMM monitors and audits access requests for hardware and system software. This can avoid fake actions and possess the merit of a HIDS. There are two different methods for implementing a VM-based IDS: Either the IDS is an independent process in each VM or a high-privileged VM on the VMM; or the IDS is integrated into the VMM

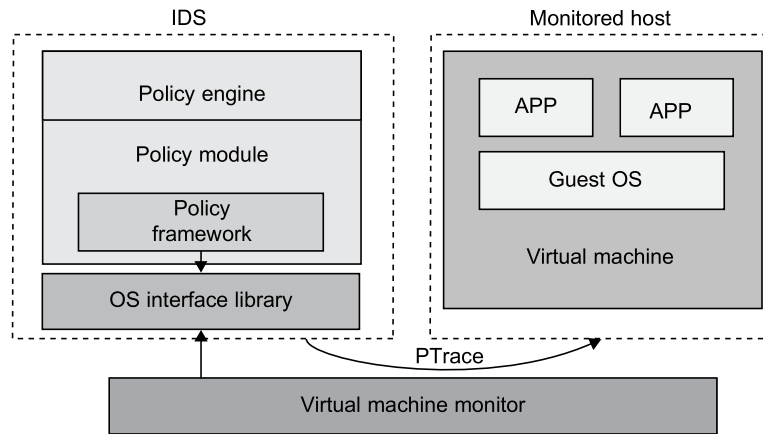
**FIGURE 3.29**

The architecture of livewire for intrusion detection using a dedicated VM.

(Courtesy of Garfinkel and Rosenblum, 2002 [17])

and has the same privilege to access the hardware as well as the VMM. Garfinkel and Rosenblum [17] have proposed an IDS to run on a VMM as a high-privileged VM. Figure 3.29 illustrates the concept.

The VM-based IDS contains a policy engine and a policy module. The policy framework can monitor events in different guest VMs by operating system interface library and PTrace indicates trace to secure policy of monitored host. It's difficult to predict and prevent all intrusions without delay. Therefore, an analysis of the intrusion action is extremely important after an intrusion occurs. At the time of this writing, most computer systems use logs to analyze attack actions, but it is hard to ensure the credibility and integrity of a log. The IDS log service is based on the operating system kernel. Thus, when an operating system is invaded by attackers, the log service should be unaffected.

Besides IDS, honeypots and honeynets are also prevalent in intrusion detection. They attract and provide a fake system view to attackers in order to protect the real system. In addition, the attack action can be analyzed, and a secure IDS can be built. A honeypot is a purposely defective system that simulates an operating system to cheat and monitor the actions of an attacker. A honeypot can be divided into physical and virtual forms. A guest operating system and the applications running on it constitute a VM. The host operating system and VMM must be guaranteed to prevent attacks from the VM in a virtual honeypot.

Example 3.14 EMC Establishment of Trusted Zones for Protection of Virtual Clusters Provided to Multiple Tenants

EMC and VMware have joined forces in building security middleware for trust management in distributed systems and private clouds. The concept of *trusted zones* was established as part of the virtual infrastructure. Figure 3.30 illustrates the concept of creating trusted zones for virtual clusters (multiple

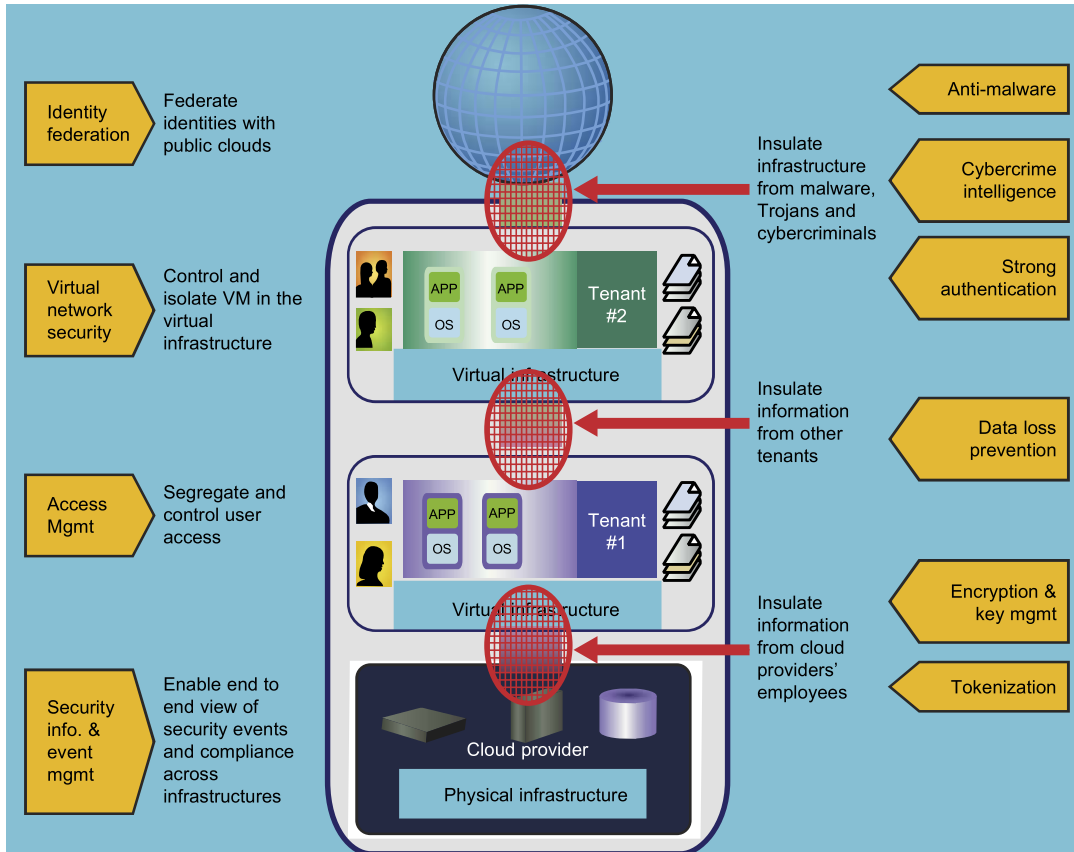

FIGURE 3.30

Techniques for establishing trusted zones for virtual cluster insulation and VM isolation.

(Courtesy of L. Nick, EMC [40])

applications and Oses for each tenant) provisioned in separate virtual environments. The physical infrastructure is shown at the bottom, and marked as a cloud provider. The virtual clusters or infrastructures are shown in the upper boxes for two tenants. The public cloud is associated with the global user communities at the top.

The arrowed boxes on the left and the brief description between the arrows and the zoning boxes are security functions and actions taken at the four levels from the users to the providers. The small circles between the four boxes refer to interactions between users and providers and among the users themselves. The arrowed boxes on the right are those functions and actions applied between the tenant environments, the provider, and the global communities.

Almost all available countermeasures, such as anti-virus, worm containment, intrusion detection, encryption and decryption mechanisms, are applied here to insulate the trusted zones and isolate the VMs for private tenants. The main innovation here is to establish the trust zones among the virtual clusters.

The end result is to enable an end-to-end view of security events and compliance across the virtual clusters dedicated to different tenants. We will discuss security and trust issues in [Chapter 7](#) when we study clouds in more detail.

3.6 BIBLIOGRAPHIC NOTES AND HOMEWORK PROBLEMS

Good reviews on virtualization technology can be found in Rosenblum, et al. [53,54] and in Smith and Nair [58,59]. White papers at [71,72] report on virtualization products at VMware, including the vSphere 4 cloud operating system. The Xen hypervisor was introduced in [7,13,42] and KVM in [31]. Qian, et al. [50] have given some theoretical treatment of the subject. ISA-level virtualization and binary translation techniques are treated in [3] and in Smith and Nair [58]. Some comparison of virtualizing software environments can be found in Buyya, et al. [9]. Hardware-level virtualization is treated in [1,7,8,13,37,43,54,67]. Intel's support of hardware-level virtualization is treated in [62]. Some entries in [Table 3.5](#) are taken from Buyya, et al. [9].

For GPU computing on VMs, the readers are referred to [57]. The x86 host virtualization is treated in [2]. Pentium virtualization is treated in [53]. I/O virtualization is

Sun Microsystems reports on OS-level virtualization in [64]. OpenVZ is introduced in its user's guide [65]. Virtualization in Windows NT machines is described in [77,78]. For GPU computing on VMs, readers are referred to [53]. The x86 host virtualization is treated in [2]. Pentium virtualization is treated in [53]. The book [24] have a good coverage of hardware support for virtualization. Virtual clusters are treated in [8,12,20,25,49,55,56]. In particular, Duke's COD is reported in [12] and Purdue's Violin in [25,55]. Memory virtualization is treated in [1,10,13,51,58,68].

Hardware-level virtualization is treated in [1,7,8,13,41,47,58,73]. Intel's support of hardware-level virtualization is treated in [68]. Wells, et al. [74] have studied multi-core virtualization. The integration of multi-core and virtualization on future CPU/GPU chips posts a very hot research area, called asymmetric CMP as reported in [33,39,63,66,74]. Architectural supports for virtualized chip multiprocessors have been also studied in [17,28,30,39,66]. The maturity of this co-design CMP approach will greatly impact the future development of HPC and HTC systems.

Server consolidation in virtualized data centers is treated in [29,39,75]. Power consumption in virtualized data centers is treated in [44,46]. Literatures [46,60,61,62] discussed the virtual resource management in data centers. Kochut gives an analytical model for virtualized data centers [32]. Security protection and trust management for virtualized data centers are treated in [18,45]. For virtual storage, readers are referred to the literature [27,36,43,48,76,79]. Specific references for the examples are identified in the figure captions or in the text description of the example. The Eucalyptus was reported in [45], vSphere in [72], Parallax in [43]. The vCUDA was reported in [57] for CUDA programming on the VMs.

Acknowledgments

This chapter is coauthored by Zhibin Yu of Huazhong University of Science and Technology (HUST), China and by Kai Hwang of USC. Dr. Hai Jin and Dr. Xiaofei Liao of HUST have extended significant technical support to this work. The authors would like to thank Dr. Zhong-Yuan Qin

of Southeast University, China, Fan Zhang of Tsinghua University, and Lizhong Chen and Zhou Zhao of USC for their assistance in drawing several sketched figures and updating the references in this chapter.

References

- [1] Advanced Micro Devices. AMD Secure Virtual Machine Architecture Reference Manual, 2008.
- [2] K. Adams, O. Agesen, A comparison of software and hardware techniques for x86 virtualization, in: Proceedings of the 12th International Conference on Architectural Support for Programming Languages and Operating Systems, San Jose, CA, October 2006, pp. 21–25.
- [3] V. Adve, C. Latner, et al., LLVA: A low-level virtual instruction set architecture, in: Proceedings of the 36th International Symposium on Micro-architecture (MICRO-36 '03), 2003.
- [4] J. Alonso, L. Silva, A. Andrzejak, P. Silva, J. Torres, High-available grid services through the use of virtualized clustering, in: Proceedings of the 8th Grid Computing Conference, 2007.
- [5] P. Anedda, M. Gaggero, et al., A general service-oriented approach for managing virtual machine allocation, in: Proceedings of the 24th Annual ACM Symposium on Applied Computing (SAC 2009), ACM Press, March 2009, pp. 9–12.
- [6] H. Andre Lagar-Cavilla, J.A. Whitney, A. Scannell, et al., SnowFlock: rapid virtual machine cloning for cloud computing, in: Proceedings of EuroSystems, 2009.
- [7] P. Barham, B. Dragovic, K. Fraser, et al., Xen and the art of virtualization, in: Proceedings of the 19th ACM Symposium on Operating System Principles (SOSP19), ACM Press, 2003, pp. 164–177.
- [8] E. Bugnion, S. Devine, M. Rosenblum, Disco: running commodity OS on scalable multiprocessors, in: Proceedings of SOSP, 1997.
- [9] R. Buyya, J. Broberg, A. Goscinski (Eds.), Cloud Computing: Principles and Paradigms, Wiley Press, New York, 2011.
- [10] V. Chadha, R. Illikkal, R. Iyer, I/O Processing in a virtualized platform: a simulation-driven approach, in: Proceedings of the 3rd International Conference on Virtual Execution Environments (VEE), 2007.
- [11] R. Chandra, N. Zeldovich, C. Sapuntzakis, M.S. Lam, The collective: a cache-based system management architecture, in: Proceedings of the Second Symposium on Networked Systems Design and Implementation (NSDI '05), USENIX, Boston, May 2005, pp. 259–272.
- [12] J. Chase, L. Grit, D. Irwin, J. Moore, S. Sprenkle, Dynamic virtual cluster in a grid site manager, in: IEEE Int'l Symp. on High Performance Distributed Computing, (HPDC-12), 2003.
- [13] D. Chisnall, The Definitive Guide to the Xen Hypervisor, Prentice Hall, International, 2007.
- [14] C. Clark, K. Fraser, S. Hand, et al., Live migration of virtual machines, in: Proceedings of the Second Symposium on Networked Systems Design and Implementation (NSDI '05), 2005, pp. 273–286.
- [15] Y. Dong, J. Dai, et al., Towards high-quality I/O virtualization, in: Proceedings of SYSTOR 2009, The Israeli Experimental Systems Conference, 2009.
- [16] E. Elnozahy, M. Kistler, R. Rajamony, Energy-efficient server clusters, in: Proceedings of the 2nd Workshop on Power-Aware Computing Systems, February 2002.
- [17] J. Frich, et al., On the potential of NoC virtualization for multicore chips, in: IEEE Int'l Conf. on Complex, Intelligent and Software-Intensive Systems, 2008, pp. 801–807.
- [18] T. Garfinkel, M. Rosenblum, A virtual machine introspection-based architecture for intrusion detection, 2002.
- [19] L. Grit, D. Irwin, A. Yumerefendi, J. Chase, Virtual machine hosting for networked clusters: building the foundations for autonomic orchestration, in: First International Workshop on Virtualization Technology in Distributed Computing (VTDC), November 2006.

- [20] D. Gupta, S. Lee, M. Vrable, et al., Difference engine: Harnessing memory redundancy in virtual machines, in: *Proceedings of the USENIX Symposium on Operating Systems Design and Implementation (OSDI '08)*, 2008, pp. 309–322.
- [21] M. Hines, K. Gopalan, Post-copy based live virtual machine migration using adaptive pre-paging and dynamic self-ballooning, in: *Proceedings of the ACM/USENIX International Conference on Virtual Execution Environments (VEE '09)*, 2009, pp. 51–60.
- [22] T. Hirofuchi, H. Nakada, et al., A live storage migration mechanism over WAN and its performance evaluation, in: *Proceedings of the 4th International Workshop on Virtualization Technologies in Distributed Computing*, 15 June, ACM Press, Barcelona, Spain, 2009.
- [23] K. Hwang, D. Li, Trusted cloud computing with secure resources and data coloring, *IEEE Internet Comput.*, (September/October) (2010) 30–39.
- [24] Intel Open Source Technology Center, *System Virtualization—Principles and Implementation*, Tsinghua University Press, Beijing, China, 2009.
- [25] X. Jiang, D. Xu, VIOLIN: Virtual internetworking on overlay infrastructure, in: *Proceedings of the International Symposium on Parallel and Distributed Processing and Applications*, 2004, pp. 937–946.
- [26] H. Jin, L. Deng, S. Wu, X. Shi, X. Pan, Live virtual machine migration with adaptive memory compression, in: *Proceedings of the IEEE International Conference on Cluster Computing*, 2009.
- [27] K. Jin, E. Miller, The effectiveness of deduplication on virtual machine disk images, in: *Proceedings of SYSTOR*, 2009, The Israeli Experimental Systems Conference, 2009.
- [28] S. Jones, A. Arpaci-Disseau, R. Arpaci-Disseau, Geiger: Monitoring the buffer cache in a virtual machine environment, in: *ACM ASPLOS*, San Jose, CA, October 2006, pp. 13–14.
- [29] F. Kamoun, Virtualizing the datacenter without compromising server performance, *ACM Ubiquity* 2009, (9) (2009).
- [30] D. Kim, H. Kim, J. Huh, Virtual snooping: Filtering snoops in virtualized multi-cores, in: *43rd Annual IEEE/ACM Int'l Symposium on Microarchitecture (MICRO-43)*.
- [31] A. Kivity, et al., KVM: The linux virtual machine monitor, in: *Proceedings of the Linux Symposium*, Ottawa, Canada, 2007, p. 225.
- [32] A. Kochut, On impact of dynamic virtual machine reallocation on data center efficiency, in: *Proceedings of the IEEE International Symposium on Modeling, Analysis and Simulation of Computers and Telecommunication Systems (MASCOTS)*, 2008.
- [33] R. Kumar, et al., Heterogeneous chip multiprocessors, *IEEE Comput. Mag.* 38 (November) (2005) 32–38.
- [34] B. Kyrre, Managing large networks of virtual machines, in: *Proceedings of the 20th Large Installation System Administration Conference*, 2006, pp. 205–214.
- [35] J. Lange, P. Dinda, Transparent network services via a virtual traffic layer for virtual machines, in: *Proceedings of High Performance Distributed Computing*, ACM Press, Monterey, CA, pp. 25–29, June 2007.
- [36] A. Liguori, E. Hensbergen, Experiences with content addressable storage and virtual disks, in: *Proceedings of the Workshop on I/O Virtualization (WIOV '08)*, 2008.
- [37] H. Liu, H. Jin, X. Liao, L. Hu, C. Yu, Live migration of virtual machine based on full system trace and replay, in: *Proceedings of the 18th International Symposium on High Performance Distributed Computing (HPDC '09)*, 2009, pp. 101–110.
- [38] A. Mainwaring, D. Culler, Design challenges of virtual networks: Fast, general-purpose communication, in: *Proceedings of the Seventh ACM SIGPLAN Symposium on Principles and Practices of Parallel Programming*, 1999.
- [39] M. Marty, M. Hill, Virtual hierarchies to support server consolidation, in: *Proceedings of the 34th Annual International Symposium on Computer Architecture (ISCA)*, 2007.

- [40] M. McNett, D. Gupta, A. Vahdat, G.M. Voelker, Usher: An extensible framework for managing clusters of virtual machines, in: 21st Large Installation System Administration Conference (LISA) 2007.
- [41] D. Menasce, Virtualization: Concepts, applications., performance modeling, in: Proceedings of the 31st International Computer Measurement Group Conference, 2005, pp. 407–414.
- [42] A. Menon, J. Renato, Y. Turner, Diagnosing performance overheads in the Xen virtual machine environment, in: Proceedings of the 1st ACM/USENIX International Conference on Virtual Execution Environments, 2005.
- [43] D. Meyer, et al., Parallax: Virtual disks for virtual machines, in: Proceedings of EuroSys, 2008.
- [44] J. Nick, Journey to the private cloud: Security and compliance, in: Technical presentation by EMC Visiting Team, May 25, Tsinghua University, Beijing, 2010.
- [45] D. Nurmi, et al., The eucalyptus open-source cloud computing system, in: Proceedings of the 9th IEEE ACM International Symposium on Cluster Computing and The Grid (CCGrid), Shanghai, China, September 2009, pp. 124–131.
- [46] P. Padala, et al., Adaptive control of virtualized resources in utility computing environments, in: Proceedings of EuroSys 2007.
- [47] L. Peterson, A. Bavier, M.E. Fiuczynski, S. Muir, Experiences Building PlanetLab, in: Proceedings of the 7th USENIX Symposium on Operating Systems Design and Implementation (OSDI2006), 6–8 November 2006.
- [48] B. Pfaff, T. Garfinkel, M. Rosenblum, Virtualization aware file systems: Getting beyond the limitations of virtual disks, in: Proceedings of USENIX Networked Systems Design and Implementation (NSDI 2006), May 2006, pp. 353–366.
- [49] E. Pinheiro, R. Bianchini, E. Carrera, T. Heath, Dynamic cluster reconfiguration for power and performance, in: L. Benini (Ed.), *Compilers and Operating Systems for Low Power*, Kluwer Academic Publishers, 2003.
- [50] H. Qian, E. Miller, et al., Agility in virtualized utility computing, in: Proceedings of the Third International Workshop on Virtualization Technology in Distributed Computing (VTDC 2007), 12 November 2007.
- [51] H. Raj, I. Ganey, K. Schwan, Self-Virtualized I/O: High Performance, Scalable I/O Virtualization in Multi-core Systems, Technical Report GIT-CERCS-06-02, CERCS, Georgia Tech, 2006, www.cercs.gatech.edu/tech-reports/tr2006/git-cercs-06-02.pdf.
- [52] J. Robin, C. Irvine, Analysis of the Intel pentium’s ability to support a secure virtual machine monitor, in: Proceedings of the 9th USENIX Security Symposium Vol. 9, 2000.
- [53] M. Rosenblum, The reincarnation of virtual machines, *ACM QUEUE*, (July/August) (2004).
- [54] M. Rosenblum, T. Garfinkel, Virtual machine monitors: current technology and future trends, *IEEE Comput* 38 (5) (2005) 39–47.
- [55] P. Ruth, et al., Automatic Live Migration of Virtual Computational Environments in a Multi-domain Infrastructure, Purdue University, 2006.
- [56] C. Sapuntzakis, R. Chandra, B. Pfaff, et al., Optimizing the migration of virtual computers, in: Proceedings of the 5th Symposium on Operating Systems Design and Implementation, Boston, 9–11 December 2002.
- [57] L. Shi, H. Chen, J. Sun, vCUDA: GPU accelerated high performance computing in virtual machines, in: Proceedings of the IEEE International Symposium on Parallel and Distributed Processing, 2009.
- [58] J. Smith, R. Nair, *Virtual Machines: Versatile Platforms for Systems and Processes*, Morgan Kaufmann, 2005.
- [59] J. Smith, R. Nair, The architecture of virtual machines, *IEEE Comput.*, (May) (2005).
- [60] Y. Song, H. Wang, et al., Multi-tiered on-demand resource scheduling for VM-based data center, in: Proceedings of the 9th IEEE/ACM International Symposium on Cluster Computing and the Grid, 2009.
- [61] B. Sotomayor, K. Keahey, I. Foster, Combining batch execution and leasing using virtual machines, in: Proceedings of the 17th International Symposium on High-Performance Distributed Computing, 2008.

- [62] M. Steinder, I. Whalley, et al., Server virtualization in autonomic management of heterogeneous workloads, *ACM SIGOPS Oper. Syst. Rev.* 42 (1) (2008) 94–95.
- [63] M. Suleman, Y. Patt, E. Sprangle, A. Rohillah, Asymmetric chip multiprocessors: balancing hardware efficiency and programming efficiency, (2007).
- [64] Sun Microsystems. Solaris Containers: Server Virtualization and Manageability, Technical white paper, September 2004.
- [65] SWsoft, Inc. OpenVZ User's Guide, <http://ftp.openvz.org/doc/OpenVZ-Users-Guide.pdf>, 2005.
- [66] F. Trivino, et al., Virtualizing network on chip resources in chip multiprocessors, *J. Microprocess. Microsyst.* 35 (2010). 245–230 <http://www.elsevier.com/locate/micro>.
- [67] J. Xu, M. Zhao, et al., On the use of fuzzy modeling in virtualized datacenter management, in: *Proceedings of the 4th International Conference on Autonomic Computing (ICAC07)*, 2007.
- [68] R. Ublig, et al., Intel virtualization technology, *IEEE Comput.*, (May) (2005).
- [69] H. Van, F. Tran, Autonomic virtual resource management for service hosting platforms, *CLOUD* (2009).
- [70] A. Verma, P. Ahuja, A. Neogi, pMapper: Power and migration cost aware application placement in virtualized systems, in: *Proceedings of the 9th International Middleware Conference*, 2008, pp. 243–264.
- [71] VMware (white paper). Understanding Full Virtualization, Paravirtualization, and Hardware Assist, www.vmware.com/files/pdf/VMware_paravirtualization.pdf.
- [72] VMware (white paper). The vSphere 4 Operating System for Virtualizing Datacenters, News release, February 2009, www.vmware.com/products/vsphere/, April 2010.
- [73] J. Walters, et al., A comparison of virtualization technologies for HPC, in: *Proceedings of Advanced Information Networking and Applications (AINA)*, 2008.
- [74] P. Wells, K. Chakraborty, G.S. Sohi, Dynamic heterogeneity and the need for multicore virtualization, *ACM SIGOPS Operat. Syst. Rev.* 43 (2) (2009) 5–14.
- [75] T. Wood, G. Levin, P. Shenoy, Memory buddies: Exploiting page sharing for smart collocation in virtualized data centers, in: *Proceedings of the 5th International Conference on Virtual Execution Environments (VEE)*, 2009.
- [76] J. Xun, K. Chen, W. Zheng, Amigo file system: CAS based storage management for a virtual cluster system, in: *Proceedings of IEEE 9th International Conference on Computer and Information Technology (CIT)*, 2009.
- [77] Y. Yu, OS-level Virtualization and Its Applications, Ph.D. dissertation, Computer Science Department, SUNY, Stony Brook, New York, December 2007.
- [78] Y. Yu, F. Guo, et al., A feather-weight virtual machine for windows applications, in: *Proceedings of the 2nd International Conference on Virtual Execution Environments (VEE)*, Ottawa, Canada, 14–16 June 2006.
- [79] M. Zhao, J. Zhang, et al., Distributed file system support for virtual machines in grid computing, in: *Proceedings of High Performance Distributed Computing*, 2004.

HOMEWORK PROBLEMS

Problem 3.1

Briefly answer the following questions on virtualization levels. Highlight the key points and identify the distinctions in different approaches. Discuss their relative advantages, shortcomings and limitations. Also identify example systems implemented at each level.

Problem 3.2

Explain the differences between hypervisor and para-virtualization and give one example VMM (virtual machine monitor), that was built in each of the two categories.

Problem 3.3

Install the VMware Workstation on a Windows XP or Vista personal computer or laptop, and then install Red Hat Linux and Windows XP in the VMware Workstation. Configure the network settings of Red Hat Linux and Windows XP to get on the Internet. Write an installation and configuration guide for the VMware Workstation, Red Hat Linux, and Windows XP systems. Include any troubleshooting tips in the guide.

Problem 3.4

Download a new kernel package from www.kernel.org/. Compile it in Red Hat Linux in the VMware Workstation installed in [Problem 3.3](#) with Red Hat Linux on a real computer. Compare the time required for the two compilations. Which one takes longer to compile? What are their major differences?

Problem 3.5

Install Xen on a Red Hat Linux machine in two methods from the binary code or from the source code. Compile installation guides for the two methods used. Describe the dependencies of utilities and packages along with troubleshooting tips.

Problem 3.6

Install Red Hat Linux on the Xen you installed in [Problem 3.5](#). Download nbench from www.tux.org/~mayer/linux/bmark.html. Run the nbench on the VM using Xen and on a real machine. Compare the performance of the programs on the two platforms.

Problem 3.7

Use the utilities for easing deployment of Google enterprise applications in VMs. The Google-vm-deployment tool can be downloaded from <http://code.google.com/p/google-vm-deployment/>.

Problem 3.8

Describe the approaches used to exchange data among the domains of Xen and design experiments to compare the performance of data communication between the domains. This is designed to familiarize you with the Xen programming environment. It may require a longer period of time to port the Xen code, implement the application code, perform the experiments, collect the performance data, and interpret the results.

Problem 3.9

Build your own LAN by using the VMware Workstation. The topological structure of the LAN is specified in [Figure 3.31](#). Machine A is required to install Red Hat Linux while machine B is required to install Windows XP.

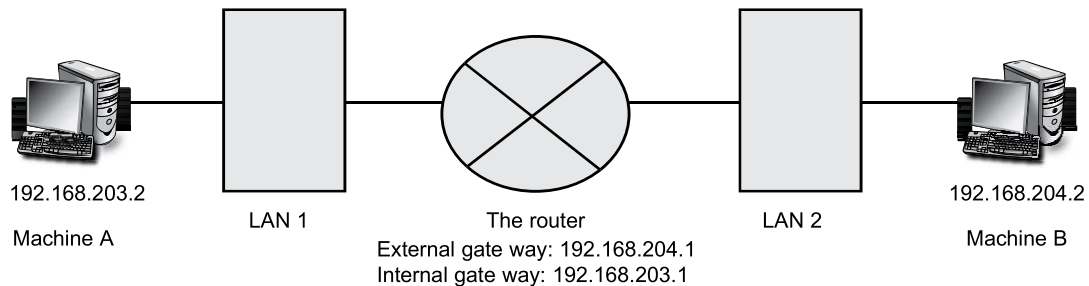
**FIGURE 3.31**

The topological structure of the virtual LAN.

Problem 3.10

Study the relevant papers [33,63,74] on asymmetric or heterogeneous chip multiprocessors (CMP). Write a study report to survey the area, identify the key research issues, review the current development and open research challenges lying ahead.

Problem 3.11

Study the relevant papers [17,28,30,66] on network on chip (NoC) and virtualization of NoC resources for multi-core CMP design and applications. Repeat Problem 3.10 with a survey report after the research study.

Problem 3.12

Hardware and software resource deployment are often complicated and time-consuming. Automatic VM deployment can significantly reduce the time to instantiate new services or reallocate resources depending on user needs. Visit the following web site for more information. http://wiki.systemimager.org/index.php/Automating_Xen_VM_deployment_with_SystemImager. Report your experience with automatic deployment using the SystemImager and Xen-tools.

Problem 3.13

Design an experiment to analyze the performance of Xen live migration for I/O read-intensive applications. The performance metrics include the time consumed by the precopy phase, the downtime, the time used by the pull phase, and the total migration time.

Problem 3.14

Design an experiment to test the performance of Xen live migration for I/O write-intensive applications. The performance metrics include the time consumed by the precopy phase, the downtime, the time used by the pull phase, and the total migration time. Compare the results with those from Problem 3.13.

Problem 3.15

Design and implement a VM execution environment for grid computing based on VMware Server. The environment should enable grid users and resource providers to use services that are unique to a VM-based approach to distributed computing. Users can define customized execution environments which can then be archived, copied, shared, and instantiated as multiple runtime clones.

Problem 3.16

Design a large-scale virtual cluster system. This problem may require three students to work together for a semester. Assume that users can create multiple VMs at one time. Users can also manipulate and configure multiple VMs at the same time. Common software such as OS or libraries are preinstalled as templates. These templates enable users to create a new execution environment rapidly. Finally, you can assume that users have their own profiles which store the identification of data blocks.

Problem 3.17

Figure 3.32 shows another VIOLIN adaptation scenario for changes in virtual environments. There are four VIOLIN applications running in two cluster domains. Trace the three steps of VIOLIN job execution and discuss the gains in resource utilization after live migration of the virtual execution

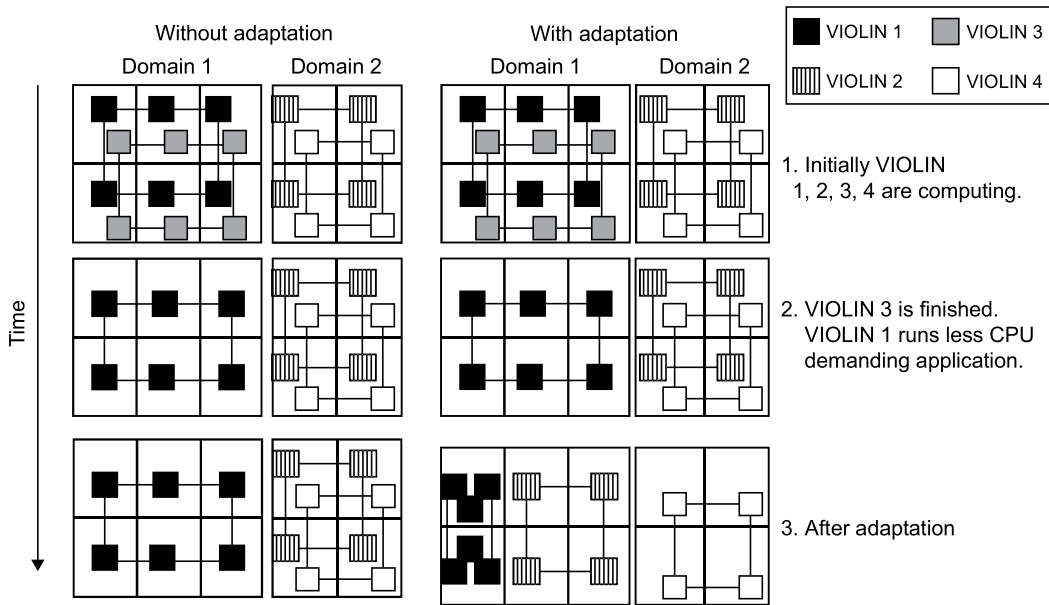

FIGURE 3.32

An adaptation scenario with four VIOLINs running in two cluster domains in the VIOLIN Virtual clustering experiments.

(Courtesy of P. Ruth, et al. [55])

environment in the two cluster domains. You can check your results against the cited paper to compare your observations.

Problem 3.18

After studying the material presented in [Section 3.3.5](#), plus reading the papers by Wells, et al. [74] and by Marty and Hill in [39] answer the following two questions:

- a.** Distinguish virtual cores from physical cores and discuss the mapping technique in Wells's paper on upgrading resource utilization and fault tolerance in using virtualized multicore processors.
- b.** Study the cache coherence protocol presented in the Marty and Hill paper and discuss its feasibility and advantages to implement on many-core CMP in the future.

This page intentionally left blank